



Digimatic Micrometer

Safety Precautions

To ensure operator safety, use this product in conformance with the directions, functions and specifications given in this User's Manual.
Use under other conditions may compromise safety.

WARNING Shows risks that could result in death or serious injury.

- Always keep batteries out of reach of children, and if swallowed, consult a physician immediately.
- Batteries should never be short-circuited, disassembled, deformed or come in contact with extreme heat or flames.
- If battery alkaline liquid comes in contact with the eyes, flush eyes immediately with clean water and consult a physician. If battery alkaline liquid comes in contact with the skin, flush the exposed area thoroughly with clean water.

CAUTION Shows risks that could result in minor or moderate injury.

- Never attempt to charge the primary battery or reverse the positive-negative terminals when mounting. Improper battery handling or mounting may cause the battery to explode, cause battery leakage and/or serious bodily injury or malfunctioning.
- Always handle the sharp measuring faces of this product with care to avoid injury.

NOTICE Shows risks that could result in property damage.

- Do not disassemble or modify.
- Do not use or store the product in a place with sudden temperature changes. Adapt the product to ambient temperature before use.
- Do not store the product in a place with high humidity or a lot of dust.
- For waterproof type products, firmly close the battery compartment cover if the product is used in a place where it is directly exposed to splashes of coolant, etc. When mounting the output cable and cover, firmly tighten the fixing screws so that there is no gap. As well, clean and apply anti-rust treatment after use. Rust may cause malfunction. For non-waterproof type products, do not use the product in a place where it may contact water or oil.
- Do not use even waterproof types submerged, as coolant ingress cannot be completely prevented. Complete prevention of coolant ingress, etc., may also not be possible if the product is used in locations exposed to direct jets of liquid.
- Do not apply excessive force or subject to sudden impacts such as dropping.
- Remove dust, cutting chips, etc. before and after use.
- When cleaning, wipe this product with a soft cloth moistened with diluted neutral detergent. Do not use an organic solvent such as thinner, which may cause the product to deform or malfunction.
- The spindle structure prevents pulling out, so do not try to forcibly retract in excess of the measurement range.
- Dirt on the spindle may lead to malfunction. If the spindle becomes dirty, wipe it clean with a cloth containing a small amount of alcohol and apply a small amount of micrometer oil (Part No. 207000).
- Do not write numbers, etc. with an electric pen.
- If the product is to be out of use for three months or more, remove the battery before storage. Liquid leakage from the battery may damage the product.

Key operation icon

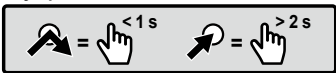

Contents

1. Names of Components	Page 1
2. Installing the Battery	Page 1
3. Precautions for Use	Page 2
4. PRESET Value (Reference Point) Setting	Page 2
5. Measurement Method	Page 2
6. Key Functions	Page 2
7. Function Lock Function (Preventing Accidental Operation)	Page 2
8. Errors and Troubleshooting	Page 2
9. Specifications	Page 3
10. Output Function	Page 3
11. Options	Page 3
12. Reference Information: Parallax and How to Read Graduations	Page 3
13. Off-Site Repairs (Subject to Charge)	Page 3

1. Names of Components

Figure shows MDC-5"MX

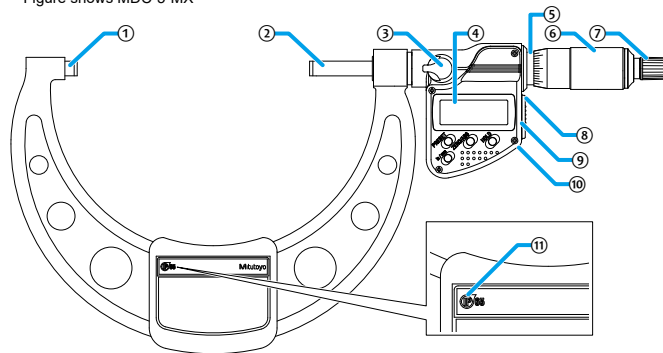

- | | |
|---------------------------------------|--|
| ① Anvil | ⑥ Thimble |
| ② Spindle | ⑦ Ratchet stop |
| ③ Swivel clamp | ⑧ Cover |
| (locks the spindle to prevent motion) | ⑨ Data output connector |
| ④ Display unit (LCD) | ⑩ Battery compartment cover (at rear) |
| ⑤ Sleeve | ⑪ Waterproof mark (waterproof type only) |

■ Display unit (LCD)

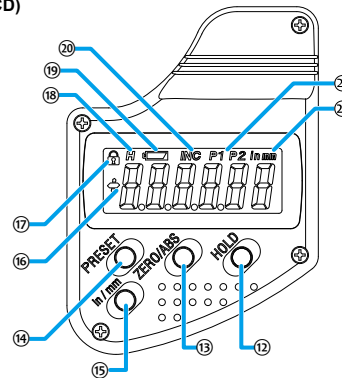

- | | |
|-------------------------------------|-----------------------|
| ⑫ [HOLD] key | ⑱ Hold display |
| ⑬ [ZERO/ABS] key | ⑲ Low voltage display |
| ⑭ [PRESET] key | ⑳ INC display |
| ⑮ [in/mm] key (in/mm products only) | ㉑ Preset display |
| ⑯ Sign display | ㉒ Unit display |
| ⑰ Function Lock display | |

2. Installing the Battery

NOTICE Shows risks that could result in property damage.

Always align the battery compartment cover with the threads and install so that the seal does not protrude. The product may display an error or malfunction if the battery compartment cover or seal is not mounted correctly.

Tips

- Be sure to use SR44 (silver oxide button battery Part No. 938882) for the battery.
- Do not rotate the thimble until the count is displayed. Initial setting of the electrical components may fail, or the product may not count normally. If you mistakenly move the thimble, reinstall the battery.
- The battery supplied is for confirming the functions and performance of the product. Note that this battery may not fulfill the predetermined life.
- Malfunction or damage due to depleted batteries, etc. is not covered by the warranty.
- Follow local rules and regulations regarding battery disposal.

The battery is not installed into the product at purchase. Install the battery as follows.

- 1 Rotate the battery compartment cover counter-clockwise to remove it.
- 2 Install the battery (SR44) with the positive side facing up.
- 3 Position the battery compartment cover and rotate clockwise to attach.
- 4 Press the [PRESET] key.

Count display appears and counting starts.

Moving on, set the PRESET value (reference point) (refer to "4. PRESET Value (Reference Point) Setting").

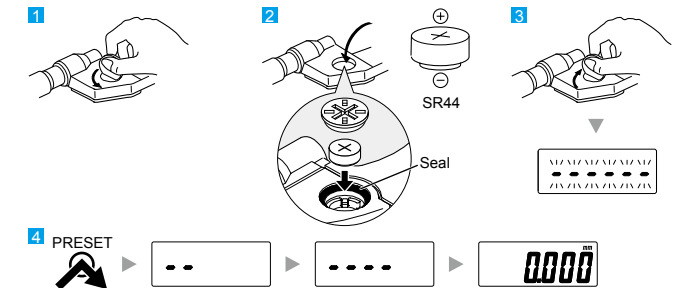

Tips

- Re-installing the battery will erase the PRESET value (reference point) position. Perform reference point setting again (refer to "4. PRESET Value (Reference Point) Setting").
- If an abnormal display is shown, such as an error display or not counting, etc., try removing the battery and reinstalling.

3. Precautions for Use

■ Measuring Force

- Use the ratchet stop to ensure consistent measuring force.
- The appropriate measuring force is achieved with the following procedure: make light contact between the measurement surfaces and the workpiece, stop momentarily, and then manually turn the ratchet stop about three to five times.

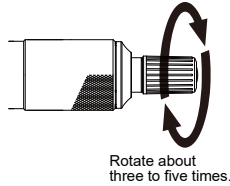

■ Precautions after Use

- After use, clean the entire product and check that none of the parts are damaged.
- If using in places exposed to water-based cutting fluid, always apply anti-rust treatment after cleaning.
- For storage, leave a gap of 0.2 to 2 mm open for the measurement surfaces, and release the swivel clamp.
- If the product will not be used for three months or longer, apply micrometer oil (Part No. 207000) to the spindle to prevent rust, and store it with its battery removed.



4. PRESET Value (Reference Point) Setting

Set an arbitrary preset value (reference point registration) prior to setting the reference point (reference point setting).

- For reference point setting, use a periodically inspected (calibrated) gage (gage block, setting standard for outside micrometer, etc.).
- Reference point setting and measurement should be made in the same orientation and conditions and with the same procedure as below.

1) Reference point registration

Register (preset) zero or gage dimensions such as a standard bar, etc. to this product. Two preset values (P1 and P2) can be registered to the product.

Tips

Press and hold the [HOLD] key to switch between P1 and P2.

<Example> Registering 125.000 mm to P1

- 1 Briefly press the [PRESET] key.
 - » The previously registered number is displayed and "P1" blinks.



Tips

- Zero will be displayed immediately after replacing the battery.
- If "P2" is blinking, press and hold the [HOLD] key to cause "P1" to blink.



- 2 Press and hold the [PRESET] key.
 - » The sign blinks.



Tips

Briefly press the [PRESET] key to switch between "+" and "-".



- 3 Press and hold the [PRESET] key.
 - » The number on the left blinks.



Tips

The numbers will switch in order from "0" to "1" to "2" up to "9" and then "0" each time the [PRESET] key is briefly pressed.



- 4 Briefly press the [PRESET] key until "1" is displayed.



- 5 Press and hold the [PRESET] key.
 - » The number in the next digit blinks.



- 6 Repeat steps 4 and 5, so that "2," "5," and "0" are displayed for each digit.



- 7 Press and hold the [PRESET] key until "P1" blinks.
- 8 Briefly press the [PRESET] key.
 - » "P1" goes out and registration is complete.



2) Reference point setting

- 1 Remove any dirt or dust from both the anvil and spindle measurement surfaces and the gage.
- 2 After making light contact with both measurement surfaces (or pinching the gage and bringing the spindle into light contact with the gage), stop momentarily, and then apply the appropriate measuring force (refer to "3. Precautions for Use ■ Measuring Force").

- 3 Press the [PRESET] key.
 - » "P1" or "P2" blinks, and the registered preset value (zero if not registered) is displayed.

Tips

- Press and hold the [HOLD] key to switch between P1 and P2.
- To change the preset value, refer to steps 2 through 8 in "1) Reference point registration".

- 4 Briefly press the [PRESET] key.
 - » "P1" or "P2" goes out.

Tips

- The display of this product automatically turns off if not used for 20 minutes or more. To display again, either rotate the thimble or press the [ZERO/ABS] key.
- If the [PRESET] key is accidentally pressed during measurement, press the [ZERO/ABS] key to return to the former state. If this does not enable the product to recover, perform "4. PRESET Value (Reference Point) Setting" once more.
- Do not handle gages (gauge blocks, setting standards for outside micrometers, etc.) with your bare hands. Use precision work gloves such as cotton gloves.

5. Measurement Method

- Be sure to perform reference point setting before measurement.
- Bring the measuring surface of the spindle slowly into contact with the workpiece. Moving too quickly could deform the workpiece and affect measurement results.

Gradually and lightly bring the measurement surfaces into contact with the workpiece in the same orientation and conditions as for reference point setting, apply the appropriate measuring force, and then read the indicated value (refer to "3. Precautions for Use ■ Measuring Force").

6. Key Functions

■ [ZERO/ABS] Key

- Briefly press the [ZERO/ABS] key.
 - » "INC" is displayed, and the display is set to zero.
- Press and hold the [ZERO/ABS] key (for at least 2 seconds).
 - » "INC" goes out, and the length from the reference point (anvil measuring surface) is displayed.

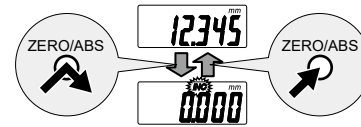

■ [HOLD] Key

- Press the [HOLD] key.
 - » "H" is displayed, and the display value is held. Press the key again to release the value.

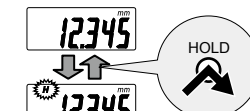

■ [in/mm] Key (in/mm products only)

- Press the [in/mm] key.
 - » "in" and "mm" switch back and forth each time the key is pressed.

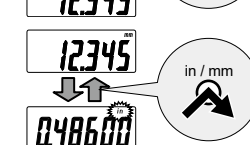

Key operation icon

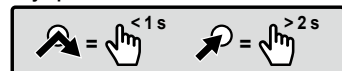

7. Function Lock Function (Preventing Accidental Operation)

This product has the Function Lock function, which disables the PRESET function and ZERO/ABS function in order to avoid accidental changes to the reference point position. Setting the Function Lock causes [L] on the LCD to light up and disables the [PRESET] key, [ZERO/ABS] key, and [in/mm] key (in/mm products only), with only the hold operation function enabled.

- 1 First press and hold the [HOLD] key, and then additionally press and hold the [ZERO/ABS] key (for at least 2 seconds).
 - » [H] display and [L] display light up in sequence ([H] turns off first).
- 2 Perform the same operation to release the Function Lock.

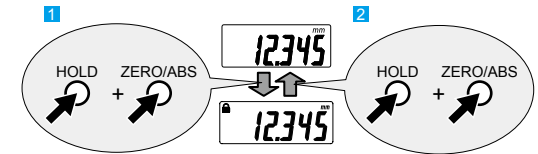

8. Errors and Troubleshooting

- "E" display
 - The battery voltage is low. Replace the battery promptly.
- "Err-oS" display
 - A counting error has occurred due to excessive speed or noise. Try removing the battery and reinstalling.
- "Err-S" display
 - Initial setting of the electrical components failed, or a counting error has occurred due to a sensor signal error. Try removing the battery and reinstalling.
- "Err-oF" display
 - The display value exceeds ± 999.999 mm (± 9.99995 in / ± 99.9999 in). Rotate the thimble in the opposite direction so that it starts counting again correctly.

