



Digimatic Micrometer

Safety Precautions

To ensure operator safety, use this product in conformance with the directions, functions and specifications given in this User's Manual.
Use under other conditions may compromise safety.

WARNING Shows risks that could result in death or serious injury.

- Always keep batteries out of reach of children, and if swallowed, consult a physician immediately.
- Batteries should never be short-circuited, disassembled, deformed or come in contact with extreme heat or flames.
- If battery alkaline liquid comes in contact with the eyes, flush eyes immediately with clean water and consult a physician. If battery alkaline liquid comes in contact with the skin, flush the exposed area thoroughly with clean water.

CAUTION Shows risks that could result in minor or moderate injury.

- Never attempt to charge the primary battery or reverse the positive-negative terminals when mounting. Improper battery handling or mounting may cause the battery to explode, cause battery leakage and/or serious bodily injury or malfunctioning.
- Always handle the sharp measuring faces of this product with care to avoid injury.

NOTICE Shows risks that could result in property damage.

- Do not disassemble or modify.
- Do not use or store the product in a place with sudden temperature changes. Adapt the product to ambient temperature before use.
- Do not store the product in a place with high humidity or a lot of dust.
- For waterproof type products, firmly close the battery compartment cover if the product is used in a place where it is directly exposed to splashes of coolant, etc. When mounting the output cable and cover, firmly tighten the fixing screws so that there is no gap. As well, clean and apply anti-rust treatment after use. Rust may cause malfunction. For non-waterproof type products, do not use the product in a place where it may contact water or oil.
- Do not use even waterproof types submerged, as coolant ingress cannot be completely prevented. Complete prevention of coolant ingress, etc., may also not be possible if the product is used in locations exposed to direct jets of liquid.
- Do not apply excessive force or subject to sudden impacts such as dropping.
- Remove dust, cutting chips, etc. before and after use.
- When cleaning, wipe this product with a soft cloth moistened with diluted neutral detergent. Do not use an organic solvent such as thinner, which may cause the product to deform or malfunction.
- The spindle structure prevents pulling out, so do not try to forcibly retract in excess of the measurement range.
- Dirt on the spindle may lead to malfunction. If the spindle becomes dirty, wipe it clean with a cloth containing a small amount of alcohol and apply a small amount of micrometer oil (Part No. 207000).
- Do not write numbers, etc. with an electric pen.
- If the product is to be out of use for three months or more, remove the battery before storage. Liquid leakage from the battery may damage the product.

Key operation icon

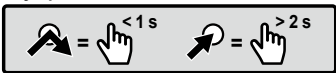

Contents

1. Names of Components	Page 1
2. Installing the Battery	Page 1
3. Precautions for Use	Page 2
4. PRESET Value (Reference Point) Setting	Page 2
5. Measurement Method	Page 2
6. Key Functions	Page 2
7. Function Lock Function (Preventing Accidental Operation)	Page 2
8. Errors and Troubleshooting	Page 2
9. Specifications	Page 3
10. Output Function	Page 3
11. Options	Page 3
12. Reference Information: Parallax and How to Read Graduations	Page 3
13. Off-Site Repairs (Subject to Charge)	Page 3

1. Names of Components

Figure shows MDC-5"MX

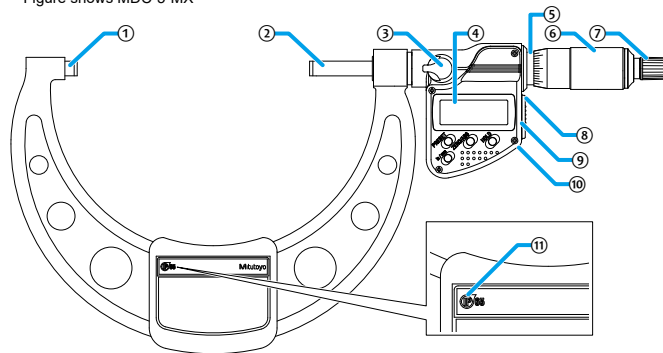

- | | |
|---------------------------------------|--|
| ① Anvil | ⑥ Thimble |
| ② Spindle | ⑦ Ratchet stop |
| ③ Swivel clamp | ⑧ Cover |
| (locks the spindle to prevent motion) | ⑨ Data output connector |
| ④ Display unit (LCD) | ⑩ Battery compartment cover (at rear) |
| ⑤ Sleeve | ⑪ Waterproof mark (waterproof type only) |

■ Display unit (LCD)

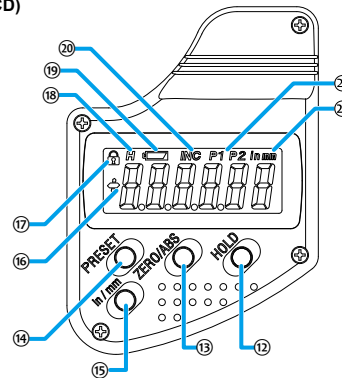

- | | |
|-------------------------------------|-----------------------|
| ⑫ [HOLD] key | ⑱ Hold display |
| ⑬ [ZERO/ABS] key | ⑲ Low voltage display |
| ⑭ [PRESET] key | ⑳ INC display |
| ⑮ [in/mm] key (in/mm products only) | ㉑ Preset display |
| ⑯ Sign display | ㉒ Unit display |
| ⑰ Function Lock display | |

2. Installing the Battery

NOTICE Shows risks that could result in property damage.

Always align the battery compartment cover with the threads and install so that the seal does not protrude. The product may display an error or malfunction if the battery compartment cover or seal is not mounted correctly.

Tips

- Be sure to use SR44 (silver oxide button battery Part No. 938882) for the battery.
- Do not rotate the thimble until the count is displayed. Initial setting of the electrical components may fail, or the product may not count normally. If you mistakenly move the thimble, reinstall the battery.
- The battery supplied is for confirming the functions and performance of the product. Note that this battery may not fulfill the predetermined life.
- Malfunction or damage due to depleted batteries, etc. is not covered by the warranty.
- Follow local rules and regulations regarding battery disposal.

The battery is not installed into the product at purchase. Install the battery as follows.

- 1 Rotate the battery compartment cover counter-clockwise to remove it.
- 2 Install the battery (SR44) with the positive side facing up.
- 3 Position the battery compartment cover and rotate clockwise to attach.
- 4 Press the [PRESET] key.

Count display appears and counting starts.

Moving on, set the PRESET value (reference point) (refer to "4. PRESET Value (Reference Point) Setting").

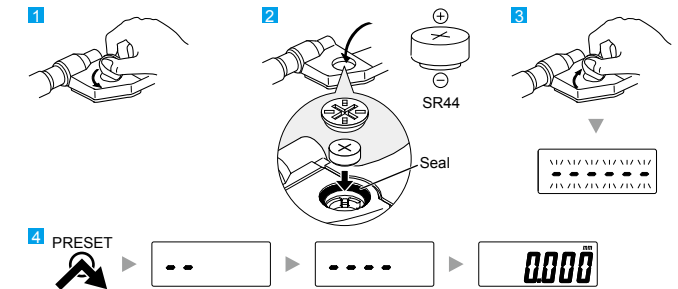

Tips

- Re-installing the battery will erase the PRESET value (reference point) position. Perform reference point setting again (refer to "4. PRESET Value (Reference Point) Setting").
- If an abnormal display is shown, such as an error display or not counting, etc., try removing the battery and reinstalling.



Tài liệu được tổng hợp bởi đội ngũ kỹ thuật của **NPOWER**
Bản quyền nội dung thuộc về **Mitutoyo**

Powered by **NAVITECH** | www.navitech.co
www.npower.com.vn

3. Precautions for Use

■ Measuring Force

- Use the ratchet stop to ensure consistent measuring force.
- The appropriate measuring force is achieved with the following procedure: make light contact between the measurement surfaces and the workpiece, stop momentarily, and then manually turn the ratchet stop about three to five times.

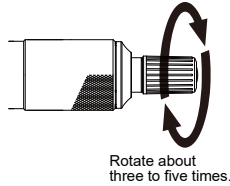

■ Precautions after Use

- After use, clean the entire product and check that none of the parts are damaged.
- If using in places exposed to water-based cutting fluid, always apply anti-rust treatment after cleaning.
- For storage, leave a gap of 0.2 to 2 mm open for the measurement surfaces, and release the swivel clamp.
- If the product will not be used for three months or longer, apply micrometer oil (Part No. 207000) to the spindle to prevent rust, and store it with its battery removed.



4. PRESET Value (Reference Point) Setting

Set an arbitrary preset value (reference point registration) prior to setting the reference point (reference point setting).

- For reference point setting, use a periodically inspected (calibrated) gage (gage block, setting standard for outside micrometer, etc.).
- Reference point setting and measurement should be made in the same orientation and conditions and with the same procedure as below.

1) Reference point registration

Register (preset) zero or gage dimensions such as a standard bar, etc. to this product. Two preset values (P1 and P2) can be registered to the product.

Tips

Press and hold the [HOLD] key to switch between P1 and P2.

<Example> Registering 125.000 mm to P1

- 1 Briefly press the [PRESET] key.
 - » The previously registered number is displayed and "P1" blinks.



Tips

- Zero will be displayed immediately after replacing the battery.
- If "P2" is blinking, press and hold the [HOLD] key to cause "P1" to blink.



- 2 Press and hold the [PRESET] key.
 - » The sign blinks.



Tips

Briefly press the [PRESET] key to switch between "+" and "-".



- 3 Press and hold the [PRESET] key.
 - » The number on the left blinks.



Tips

The numbers will switch in order from "0" to "1" to "2" up to "9" and then "0" each time the [PRESET] key is briefly pressed.



- 4 Briefly press the [PRESET] key until "1" is displayed.



- 5 Press and hold the [PRESET] key.
 - » The number in the next digit blinks.



- 6 Repeat steps 4 and 5, so that "2," "5," and "0" are displayed for each digit.



- 7 Press and hold the [PRESET] key until "P1" blinks.
- 8 Briefly press the [PRESET] key.
 - » "P1" goes out and registration is complete.



2) Reference point setting

- 1 Remove any dirt or dust from both the anvil and spindle measurement surfaces and the gage.
- 2 After making light contact with both measurement surfaces (or pinching the gage and bringing the spindle into light contact with the gage), stop momentarily, and then apply the appropriate measuring force (refer to "3. Precautions for Use ■ Measuring Force").

- 3 Press the [PRESET] key.
 - » "P1" or "P2" blinks, and the registered preset value (zero if not registered) is displayed.

Tips

- Press and hold the [HOLD] key to switch between P1 and P2.
- To change the preset value, refer to steps 2 through 8 in "1) Reference point registration".

- 4 Briefly press the [PRESET] key.
 - » "P1" or "P2" goes out.

Tips

- The display of this product automatically turns off if not used for 20 minutes or more. To display again, either rotate the thimble or press the [ZERO/ABS] key.
- If the [PRESET] key is accidentally pressed during measurement, press the [ZERO/ABS] key to return to the former state. If this does not enable the product to recover, perform "4. PRESET Value (Reference Point) Setting" once more.
- Do not handle gages (gage blocks, setting standards for outside micrometers, etc.) with your bare hands. Use precision work gloves such as cotton gloves.

5. Measurement Method

- Be sure to perform reference point setting before measurement.
- Bring the measuring surface of the spindle slowly into contact with the workpiece. Moving too quickly could deform the workpiece and affect measurement results.

Gradually and lightly bring the measurement surfaces into contact with the workpiece in the same orientation and conditions as for reference point setting, apply the appropriate measuring force, and then read the indicated value (refer to "3. Precautions for Use ■ Measuring Force").

6. Key Functions

■ [ZERO/ABS] Key

- Briefly press the [ZERO/ABS] key.
 - » "INC" is displayed, and the display is set to zero.
- Press and hold the [ZERO/ABS] key (for at least 2 seconds).
 - » "INC" goes out, and the length from the reference point (anvil measuring surface) is displayed.

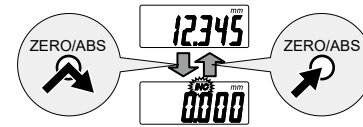

■ [HOLD] Key

- Press the [HOLD] key.
 - » "H" is displayed, and the display value is held. Press the key again to release the value.

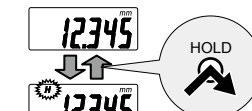

■ [in/mm] Key (in/mm products only)

- Press the [in/mm] key.
 - » "in" and "mm" switch back and forth each time the key is pressed.

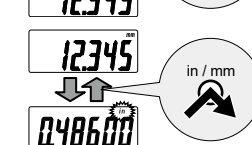

Key operation icon

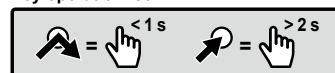

7. Function Lock Function (Preventing Accidental Operation)

This product has the Function Lock function, which disables the PRESET function and ZERO/ABS function in order to avoid accidental changes to the reference point position. Setting the Function Lock causes [L] on the LCD to light up and disables the [PRESET] key, [ZERO/ABS] key, and [in/mm] key (in/mm products only), with only the hold operation function enabled.

- 1 First press and hold the [HOLD] key, and then additionally press and hold the [ZERO/ABS] key (for at least 2 seconds).
 - » [H] display and [L] display light up in sequence ([H] turns off first).
- 2 Perform the same operation to release the Function Lock.

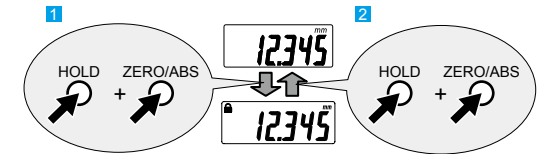

8. Errors and Troubleshooting

- "E" display
 - The battery voltage is low. Replace the battery promptly.
- "Err-oS" display
 - A counting error has occurred due to excessive speed or noise. Try removing the battery and reinstalling.
- "Err-S" display
 - Initial setting of the electrical components failed, or a counting error has occurred due to a sensor signal error. Try removing the battery and reinstalling.
- "Err-oF" display
 - The display value exceeds ± 999.999 mm (± 9.99995 in / ± 99.9999 in). Rotate the thimble in the opposite direction so that it starts counting again correctly.



Tài liệu được tổng hợp bởi đội ngũ kỹ thuật của NPOWER
Bản quyền nội dung thuộc về Mitutoyo

Powered by NAVITECH | www.navitech.co

www.npower.com.vn

9. Specifications

Common Specifications

Display : LCD (6-digit and minus sign)
 Power supply : Button type silver-oxide battery (SR44 No.938882), x1
 Battery life : Approximately 2.4 years
 Temperature range : 5 °C to 40 °C (operating temperature), -10 °C to 60 °C (storage temperature)
 Standard accessories : Wrench (No.301336), standard bar (refer to the individual specifications below for applicable products)

Individual Specifications

Series No.	Maximum measuring length	Maximum permissible error J_{MPE}^{*1}	Resolution	Measuring force	Waterproof functionality ³	Standard bar
293	125, 150 mm	$\pm 2 \mu\text{m}$	0.001 mm	5 - 10 N	✓	✓
	175, 200, 225 mm	$\pm 3 \mu\text{m}$				
	250, 275, 300 mm	$\pm 4 \mu\text{m}$				
	5, 6 in	$\pm 0.0001 \text{ in}$	0.0001 in			
	7, 8, 9 in	$\pm 0.00015 \text{ in}$				
10, 11, 12 in	$\pm 0.0002 \text{ in}$					
314	15 mm	$\pm 4 \mu\text{m}$	0.001 mm	3 - 8 N	✓	✓
	25 mm	$\pm 4 \mu\text{m}$		5 - 10 N		
	40 mm	$\pm 5 \mu\text{m}$	0.0005 in	3 - 8 N		
	0.6 in	$\pm 0.0002 \text{ in}$		5 - 10 N		
	1 in	$\pm 0.00025 \text{ in}$				
345	30 mm	$\pm 5 \mu\text{m}$	0.001 mm	1 - 6 N	✓ ⁷	✓
	50 mm	$\pm 6 \mu\text{m}$				
	1.2 in	$\pm 0.00025 \text{ in}$				
350	25 mm	$\pm 2 \mu\text{m}$	0.001 mm	5 - 10 N	✓ ⁷	✓
	1 in	$\pm 0.0001 \text{ in}$				
324 ⁴ 326	25, 50, 75 mm	3 μm	0.001 mm	5 - 10 N	✓	✓ ⁸
	100 mm	3 μm				
	1, 2, 3 in	0.00015 in				
	4 in	0.00015 in				
329 ⁵	150, 300 mm	3 μm	0.001 mm	5 - 10 N	✓	✓
	6 in	0.00005 in				
	12 in	0.00015 in				
340 ⁶	150 mm	3 μm	0.001 mm	5 - 10 N	✓	✓ ⁹
	300 mm	3 μm				
	6 in	0.00015 in				
	12 in	0.00015 in				

*1: Maximum permissible error for indicated value via contact with full measuring face J_{MPE} (20 °C).

*2: Value at 20 °C.

*3: IP protection level :

IP65 (refer to IEC60529 for details).

Dust-proof (level 6) : No ingress of dust allowed.

Protection against water jets (level 5) : Protects the equipment against water jets from any direction.

*4: 324 Series ball contact points are optional; 326 Series spare contact points are optional.

*5: Rod reference point error $\pm(2+L/75) \mu\text{m}$, L is the maximum measuring length (mm) (fractions rounded up).

*6: Spare anvils are standard accessories.

*7: Excluding some models.

*8: 0 to 25 mm (0 to 1 in) size not included.

*9: Five or six are standard accessories.

10. Output Function

Display Value External Output

The display value can be output to a device by connecting the product and the external device with a connection cable (option).

Connection Cable Installation Method

NOTICE Shows risks that could result in property damage.

- Always use the 0-size Phillips screwdriver (No.05CZA619) supplied with the connection cable (option) when installing/removing screws, and tighten to a torque of 5 to 8 cN·m or so. Otherwise, it may cause damage.
- When connecting the connection cable, ensure that the connector gasket does not protrude. If the connector gasket is not installed properly, waterproof functionality may decrease and lead to malfunctions.

- Use the Phillips screwdriver supplied with the connection cable to remove the cover fixing screws (M1.7 x 0.35 x 2.5, No.09GAA376).
- Remove the cover.
- Check that the connector gasket (No.04AAC126) is correctly installed at the proper position (do not remove the connector gasket).
- Mount the connection cable plug.
- Hold the plug manually so that there is no gap between the plug and the connector on the micrometer body, and fasten using the fixing screws on the connection cable.

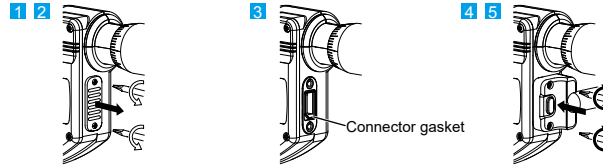

Output Data Format

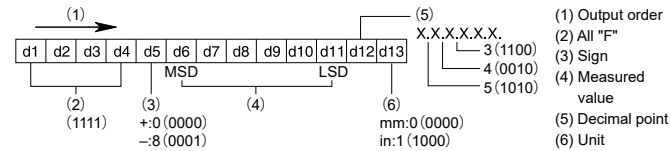

Timing Chart

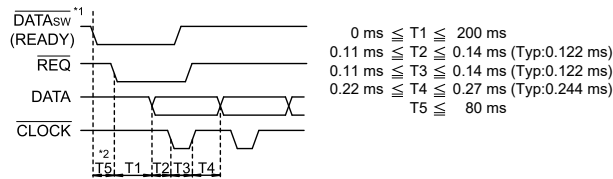

*1: DATAsw is LOW while the data output key is being pressed.

*2: The time T5 until DATAsw goes to the LOW level and REQ is input is determined by the data processing device performance.

11. Options

- Connection cable: No.05CZA662 (1 m)
- Connection cable: No.05CZA663 (2 m)

For options other than the above, refer to the General Catalog.

12. Reference Information: Parallax and How to Read Graduations

Parallax

- When using a micrometer, the reference line surface on the sleeve and the graduation line surface on the thimble are not on the same plane, so the point where the two lines meet will vary depending on the position of your eyes. When reading measured values, do so perpendicular from the point where the reference line on the sleeve matches the graduation line on the thimble.
- If looking from a different direction (as in the figure), there will be a parallax of roughly 2 μm .

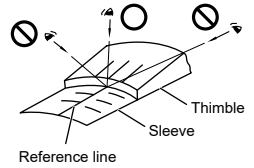

How to Read Graduations

Reference graduations (graduation 0.01 mm)

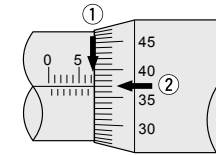

$$\begin{array}{r} \textcircled{1} \text{ Sleeve reading} \quad 7 \text{ mm} \\ \textcircled{2} \text{ Thimble reading} \quad + 0.37 \text{ mm} \\ \hline \text{Micrometer reading} \quad 7.37 \text{ mm} \end{array}$$

For $\textcircled{2}$ (0.37 mm), read the location where the reference line on the sleeve matches the graduation line on the thimble.

This is normally read up to a graduation of 0.01 mm (as shown in the figure above). However, it is also possible to read up to a graduation of 0.001 mm (as shown in the figure below).

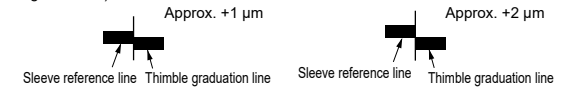

13. Off-Site Repairs (Subject to Charge)

Off-site repair (subject to charge) is required in the case of the following malfunctions. Contact your nearest dealer or our sales office.

- Faulty spindle operation
If the spindle is scratched, these scratches may interfere while the spindle is retracting, causing faulty operation.
Operation may also suffer if the spindle is rusted.
- Inconsistent measured values
If there are burrs or nicks generated by an impact on the measuring surfaces, it may affect measurement repeatability.
- Count value error/faulty operation
If the thimble of this product is retracted too far, the internal sensor will be damaged. This may cause count errors or faulty operation.



Tài liệu được tổng hợp bởi đội ngũ kỹ thuật của NPOWER
 Bản quyền nội dung thuộc về Mitutoyo

Powered by NAVITECH | www.navitech.vn

www.npower.com.vn

Digimatic Micrometer



Safety Precautions

To ensure operator safety, use this product according to the directions, functions and specifications given in this User's Manual.

Use under other conditions may compromise safety.

WARNING Shows risks that could result in death or serious injury.

- Always keep batteries out of reach of children, and if swallowed, consult a physician immediately.
- Batteries should never be short-circuited, disassembled, deformed or come in contact with extreme heat or flames.
- If battery alkaline liquid comes in contact with the eyes, flush eyes immediately with clean water and consult a physician. If battery alkaline liquid comes in contact with the skin, flush the exposed area thoroughly with clean water.

CAUTION Shows risks that could result in minor or moderate injury.

- Never attempt to charge the primary battery or reverse the positive-negative terminals when mounting. Improper battery handling or mounting may cause the battery to explode, cause battery leakage, serious bodily injury, or malfunction.
- Always handle the sharp measuring faces of this product with care to avoid injury.

NOTICE Shows risks that could result in property damage.

- Do not disassemble or modify.
- Do not use or store the product in a place with sudden temperature changes. Also, before using the product, allow it to acclimate to room temperature.
- Do not store the product in a place with high humidity or a lot of dust. Do not use the product in an environment where it may contact water or oil.
- Do not apply excessive force or subject the product to sudden impacts such as dropping.
- Remove dust, cutting chips, etc. before and after use.
- When cleaning, wipe this product with a soft cloth moistened with diluted neutral detergent. Do not use an organic solvent such as thinner, which may cause the product to deform or malfunction.
- The spindle is structured so that it cannot be pulled out. Do not forcibly retract it in excess of the measuring range.
- Dirt on the spindle may lead to malfunction. If the spindle becomes dirty, wipe it clean with a cloth containing a small amount of alcohol and apply a small amount of micrometer oil (Part No. 207000).
- If Micrometer Oil is not available and you must use a commercially available product, we recommend using an anti-rust agent with low viscosity almost equivalent to ISO VG10.
- Do not write numbers, etc. with an electric pen.
- If the product is to be out of use for three months or more, remove the batteries before storage. Liquid leakage from the battery may damage the product.

Key operation icon

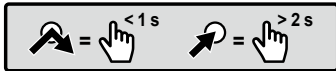

Contents

1. Names of Components	Page 1
2. Installing the Battery.....	Page 2
3. Precautions for Use.....	Page 2
4. Interchangeable Anvil Replacement Method (340 Series Only).....	Page 2
5. PRESET Value (Reference Point) Setting.....	Page 2
6. Measurement Method	Page 3
7. Display Unit Angle Adjustment	Page 3
8. Key Functions	Page 3
9. Function Lock Function (Preventing Accidental Operation)	Page 3
10. Errors and Troubleshooting	Page 3
11. Specifications	Page 4
12. Output Function	Page 4
13. Optional Accessories	Page 4
14. Off-Site Repairs (Subject to Charge).....	Page 4

1. Names of Components

293 Series MDC-MB

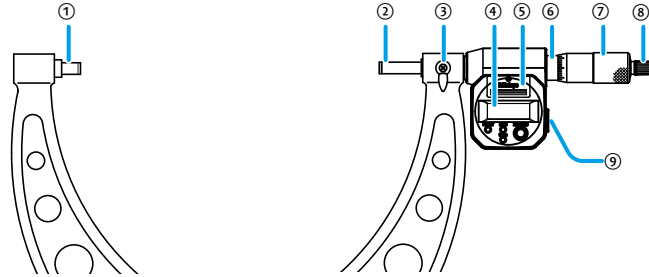

340 Series OMC-MB

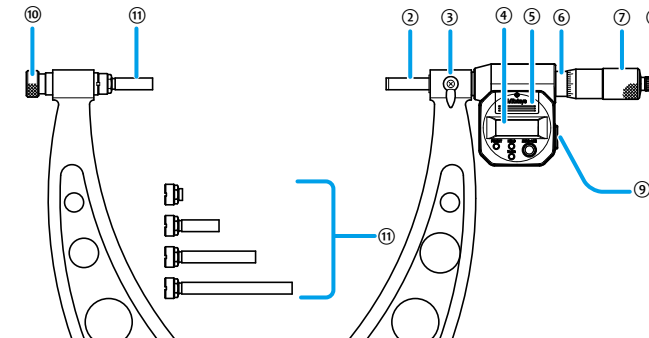

389 Series PMU-MB

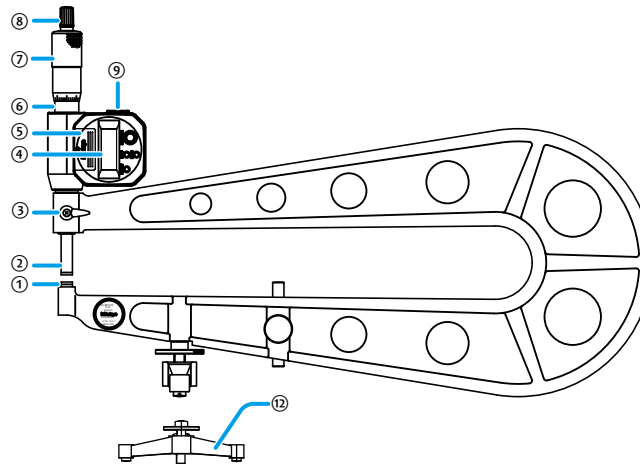

- | | |
|---|-------------------------|
| ① Anvil | ⑦ Thimble |
| ② Spindle | ⑧ Ratchet stop |
| ③ Swivel clamp
(locks the spindle to prevent motion) | ⑨ Data output connector |
| ④ Display unit (LCD) | ⑩ Tightening screw |
| ⑤ Battery compartment cover | ⑪ Interchangeable anvil |
| ⑥ Sleeve | ⑫ Stand |

Display Unit (LCD)

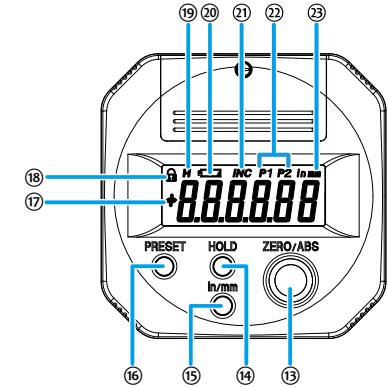

- | | |
|------------------------------------|-----------------------|
| ⑬ [ZERO/ABS] key | ⑱ Hold display |
| ⑭ [HOLD] key | ⑳ Low voltage display |
| ⑮ [in/mm] key (in/mm product only) | ㉑ INC display |
| ⑯ [PRESET] key | ㉒ Preset display |
| ⑰ Sign display | ㉓ Unit display |
| ⑰ Function Lock display | |



Tài liệu được tổng hợp bởi đội ngũ kỹ thuật của **NPOWER**
Bản quyền nội dung thuộc về **Mitutoyo**

Powered by **NAVITECH** | www.navitech.co

www.npower.com.vn

2. Installing the Battery

Tips

- Be sure to use SR44 (button type silver-oxide battery Part No. 938882) for the battery.
- Do not rotate the thimble until the count is displayed. Initial setting of the control unit may fail and the product may not count normally. If you mistakenly move the thimble, reinstall the batteries.
- The batteries supplied are for confirming the functions and performance of the product. Note that these batteries may not fulfill the predetermined life.
- Malfunction or damage due to depleted batteries, etc. is not covered by the warranty.
- Follow local rules and regulations regarding battery disposal.

The batteries are not installed into the product at purchase. Install the batteries as follows.

- 1 Use the supplied Phillips screwdriver (No.05CAA952) to loosen the battery compartment cover fixing screw (No.04GAB130), and then remove the battery compartment cover.
- 2 If replacing the existing batteries, remove the old batteries.
- 3 Install the batteries (SR44) with the positive side facing up.
- 4 Place the battery compartment cover over the battery compartment and hold down the edge with your fingers while making sure there is no gap between the cover and body, and then tighten it using the screw.
 - » The "----" display blinks.
- 5 Press the [PRESET] key.
 - » Count display appears and counting starts.

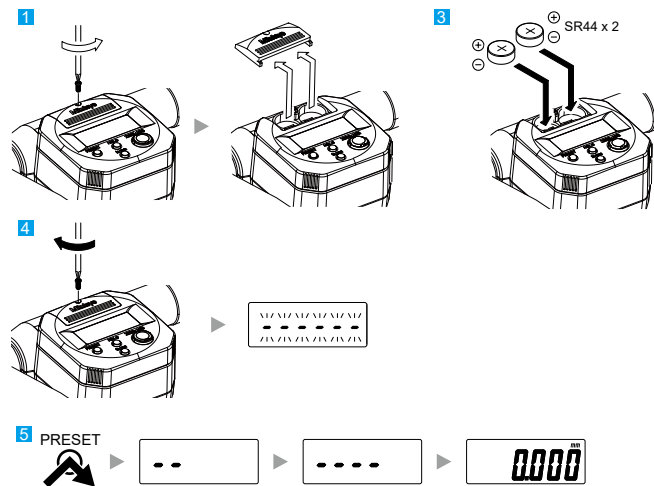

Tips

- Reinstalling the batteries will erase the PRESET value (reference point). Perform reference point setting again (see "5. PRESET Value (Reference Point) Setting").
- If an abnormal display that indicates an error or counting failure, etc., is shown, try removing the batteries and reinstalling.

Key operation icon



3. Precautions for Use

Measuring Force

- Use the ratchet stop to ensure consistent measuring force.
- The appropriate measuring force is achieved with the following procedure: bring the measurement surfaces and the workpiece into light contact with each other, stop momentarily, and then manually turn the ratchet stop about three to five times.

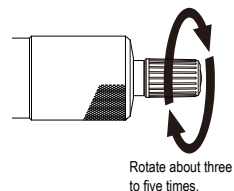

Precautions for Measurement

- Use caution when measuring magnetized workpieces. If the product becomes magnetized, measurement results may be affected.

Precautions after Use

- After use, clean the entire product and check that none of the parts are damaged. If using in places exposed to water-based cutting fluid, always apply anti-rust treatment after cleaning.
- For storage, leave a gap of 0.2 to 2 mm open for the measurement surfaces, and release the swivel clamp.
- If the product will not be used for three months or longer, apply micrometer oil (Part No. 207000) to the spindle to prevent rust, and store it with its battery removed.
- If Micrometer Oil is not available and you must use a commercially available product, we recommend using an anti-rust agent with low viscosity almost equivalent to ISO VG10.

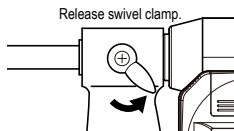

4. Interchangeable Anvil Replacement Method (340 Series Only)

Install the interchangeable anvil for the 340 series and then measure.

- 1 See the following conversion table and select the specified interchangeable anvil that matches the length of the workpiece.

Conversion table

Measuring range [mm]	Measuring range for each anvil sign [mm]			
	M3	M4	M5	M6
300-400	300-325	325-350	350-375	375-400
400-500	400-425	425-450	450-475	475-500
500-600	500-525	525-550	550-575	575-600
600-700	600-625	625-650	650-675	675-700
700-800	700-725	725-750	750-775	775-800
800-900	800-825	825-850	850-875	875-900
900-1000	900-925	925-950	950-975	975-1000

Measuring range [in]	Measuring range for each anvil sign [in]					
	M1	M2	M3	M4	M5	M6
12"-18"	12"-13"	13"-14"	14"-15"	15"-16"	16"-17"	17"-18"
18"-24"	18"-19"	19"-20"	20"-21"	21"-22"	22"-23"	23"-24"
24"-30"	24"-25"	25"-26"	26"-27"	27"-28"	28"-29"	29"-30"
30"-36"	30"-31"	31"-32"	32"-33"	33"-34"	34"-35"	35"-36"

Tips

Be aware that the M6 interchangeable anvil does not have a sign on the anvil itself.

<Example> When switching from interchangeable anvil sign M4 to M5

- 2 Loosen the tightening screw and remove the interchangeable anvil (M4).

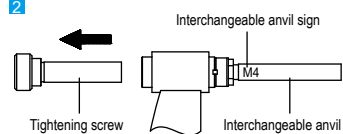

- 3 Cleanly remove the dirt from surface A of the anvil bush and surface B of the selected interchangeable anvil (M5).

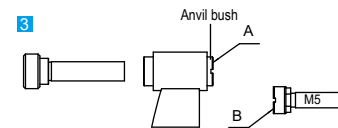

- 4 Align the marking of the interchangeable anvil with the marking of the anvil bush, and secure them with the tightening screw.

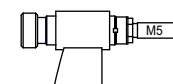
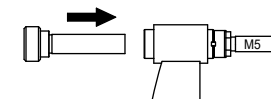
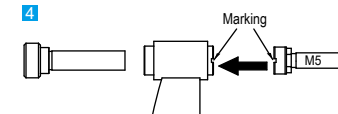

- 5 Use the standard bar to set the reference point and begin measuring (see "5. PRESET Value (Reference Point) Setting").

5. PRESET Value (Reference Point) Setting

Set an arbitrary preset value (reference point registration) prior to setting the reference point.



- For reference point setting, use a periodically inspected (calibrated) gage (gauge block, setting standard for outside micrometer, etc.).
- Reference point setting and measurement should be made in the same orientation and conditions with the procedure as below.

1) Reference point registration

Register (preset) zero or gage dimensions such as a standard bar, etc. to this product. Two preset values (P1 and P2) can be registered to the product.

Tips

Press and hold the [HOLD] key to switch between P1 and P2.

<Example> Registering 300.000 mm to P1

- 1 Briefly press the [PRESET] key.
 - » The previously registered number is displayed and [P1] blinks.



Tips

- Zero will be displayed immediately after replacing the batteries.
- If [P2] is blinking, press and hold the [HOLD] key to cause [P1] to blink.

- 2 Press and hold the [PRESET] key.
 - » The sign blinks.



Tips

Briefly press the [PRESET] key to switch between [+] and [-].

- 3 Press and hold the [PRESET] key.
 - » The leftmost number blinks.



Tips

The numbers will switch in order from [0] to [1] to [2] up to [9] and then [0] each time the [PRESET] key is briefly pressed.

4 Briefly press the [PRESET] key until [3] is displayed.



5 Press and hold the [PRESET] key.
 >> The number in the next digit blinks.



6 Repeat steps 4 and 5, so that [3], [0], [0], [0], [0], and [0] are displayed for the digits.

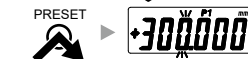

7 Press and hold the [PRESET] key until [P1] blinks.

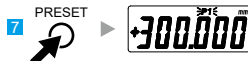

8 Briefly press the [PRESET] key.
 >> [P1] is cleared and registration is complete.



2) Reference point setting

- Remove any dirt or dust from both the anvil and spindle measurement surfaces and the gage.
- Bring the measurement surfaces into light contact with each other (or pinch the gage and bring the spindle into light contact with the gage), stop momentarily, and then apply the appropriate measuring force (see "3. Precautions for Use ■ Measuring Force").
- Press the [PRESET] key.
 >> [P1] or [P2] blinks, and the registered preset value (zero if not registered) is displayed.

Tips

- Press and hold the [HOLD] key to switch between P1 and P2.
- To change the preset value, see steps 2 through 7 in "1) Reference point registration".

4 Briefly press the [PRESET] key.
 >> [P1] or [P2] is cleared.

Tips

- The display of this product automatically turns off if not used for 20 minutes or more. To display again, either rotate the thimble or press the [ZERO/ABS] key.
- If the [PRESET] key is accidentally pressed during measurement, press the [ZERO/ABS] key to return to the former state. If this does not enable the product to recover, perform "5. PRESET Value (Reference Point) Setting" once more.
- Do not handle gages (gauge blocks, setting standards for outside micrometers, etc.) with your bare hands. Use precision work gloves such as cotton gloves.

6. Measurement Method

- Be sure to perform reference point setting before measurement.
- Bring the measurement surface of the spindle slowly into contact with the workpiece. Moving too quickly could deform the workpiece and affect measurement results.

Gradually and lightly bring the measurement surfaces into contact with the workpiece in the same orientation and conditions as for reference point setting, apply the appropriate measuring force, and then read the display value (see "3. Precautions for Use ■ Measuring Force").

Key operation icon

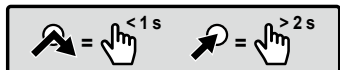

7. Display Unit Angle Adjustment

Turn the bezel to rotate the display unit. After mounting the product, adjust it to an angle which is easy to read. The display unit can be rotated up to 240° to the right (clockwise) and 90° to the left.

- The specification of the display unit does not allow rotations in excess of the above angles for the stopper. Exercise caution and do not rotate beyond the specified range. This may cause damage.

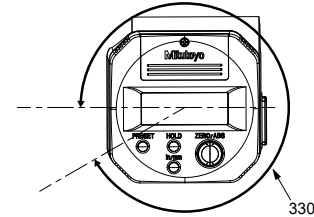

- Do not pull the display unit out or press it in forcefully. This may cause damage.

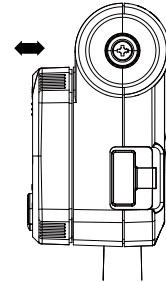

8. Key Functions

■ [ZERO/ABS] Key

- Briefly press the [ZERO/ABS] key.
 >> [INC] is displayed, and the display is set to zero.
- Press and hold the [ZERO/ABS] key (for at least 2 seconds).
 >> [INC] is cleared, and the length from the reference point (anvil measurement surface) is displayed.

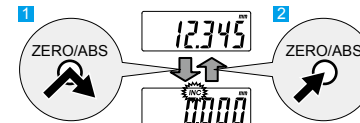

■ [HOLD] Key

- Press the [HOLD] key.
 >> [H] is displayed, and the display value is held.
- Press the key again to release the value.

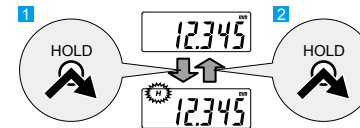

■ [in/mm] Key (in/mm Products Only)

- Press the [in/mm] key.
 >> [in] and [mm] switch back and forth each time the key is pressed.

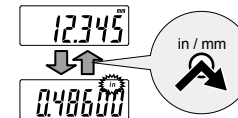

9. Function Lock Function (Preventing Accidental Operation)

This product has the Function Lock function, which disables the PRESET function and ZERO/ABS function in order to avoid accidental changes to the reference point position.

Setting the Function Lock causes [L] on the display unit to light up and disables the [PRESET] key, [ZERO/ABS] key, and [in/mm] key (in/mm product only), with only the Hold operation function enabled.

- First press and hold the [HOLD] key, and then additionally press and hold the [ZERO/ABS] key (for at least 2 seconds).
 >> [H] and [L] light up in sequence ([H] turns off first).
- Perform the same operation to release the Function Lock.

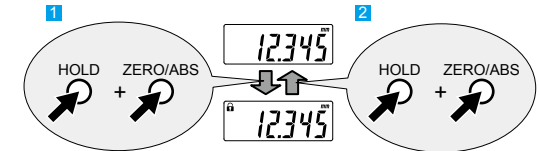

10. Errors and Troubleshooting

Error display	Causes and countermeasures
Power Voltage Drop 	The battery voltage is low. Replace the batteries promptly.
Counting Error 	A counting error has occurred due to excessive speed or noise. Try removing the batteries and reinstalling. If it does not recover after being reset, repair is required; please contact the agent where you purchased the product or a Mitutoyo sales representative.
Counting Error 	Initial setting of the control unit failed, or a counting error has occurred due to a sensor signal error. Try removing the batteries and reinstalling. If it does not recover after being reset, repair is required; please contact the agent where you purchased the product or a Mitutoyo sales representative.
Display Overflow 	The display value exceeds ±999.999. Rotate the thimble in the opposite direction so that it starts counting again correctly.



Tài liệu được tổng hợp bởi đội ngũ kỹ thuật của NPOWER
 Bản quyền nội dung thuộc về Mitutoyo

Powered by NAVITECH | www.navitech.co
 www.npower.com.vn

11. Specifications

Series No.	Maximum measuring length	Maximum permissible error J_{MPE}^{*1}
293	325, 350, 375 mm	$\pm 6 \mu\text{m}$
	400, 425, 450 mm	$\pm 7 \mu\text{m}$
	475, 500 mm	$\pm 8 \mu\text{m}$
	13, 14, 15 in	$\pm 0.0003 \text{ in}$
	16, 17, 18 in	$\pm 0.00035 \text{ in}$
	19, 20 in	$\pm 0.0004 \text{ in}$
389	25 mm	$\pm 5 \mu\text{m}$
	1 in	$\pm 0.00035 \text{ in}$
Series No.	Spindle feed error (20 °C)	
340	3 μm	
	0.00015 in	

*1: Maximum permissible error for indicated value via contact with the full measuring face J_{MPE} (20 °C).

Resolution:	0.001 mm 0.00005 in (in/mm products only)
Display unit:	LCD (6-digit and minus sign)
Power supply:	Button type silver-oxide battery (SR44 No.938882), x2
Battery life:	Approximately 1.8 years
Temperature range:	5 °C to 40 °C (operating temperature), -10 °C to 60 °C (storage temperature)
Standard accessories:	Phillips screwdriver (No. 05CAA952)
CE marking/ UKCA marking:	EMC Directive/Electromagnetic Compatibility Regulations: EN 61326-1 Immunity test requirement: Clause 6.2 Table 2 Emission limit: Class B RoHS Directive/The Restriction of the Use of Certain Hazardous Substances in Electrical and Electronic Equipment Regulations: EN IEC 63000

12. Output Function

■ Display Value External Output

The display value can be output to a device by connecting the product and the external device with a connecting cable (optional accessory).

■ Connecting Cable Installation Method

- 1 Remove the connector cap.
- 2 Mount the connecting cable plug.

Tips

Note that using this product in a location with high noise may cause malfunctions (flickering or errors).

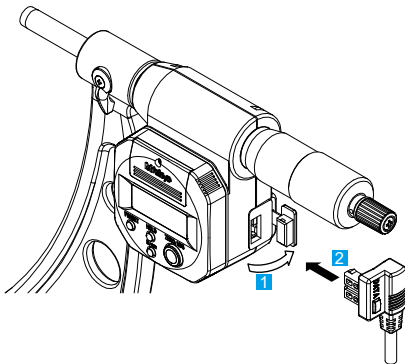

■ Output Data Format

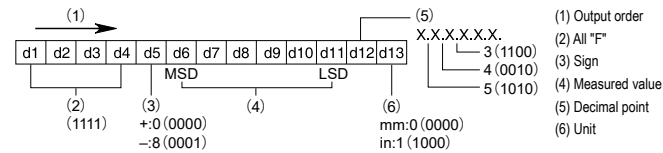

■ Timing Chart

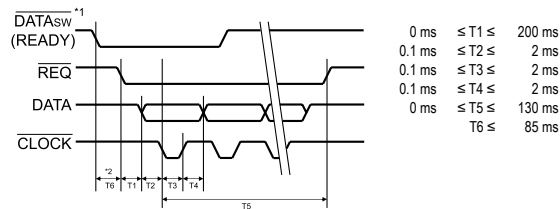

*1: DATAsw is LOW while the data output key is being pressed.

*2: The time $T6$ until DATAsw goes to the LOW level and REQ is input is determined by the data processing device performance.

13. Optional Accessories

■ Connecting Cable

Recommended products: L-type (The cable will not interfere when the thimble is operated.)

- Connecting cable: No.04AZB512 (1 m)
- Connecting cable: No.04AZB513 (2 m)

Straight type (Be careful of the cable when operating the thimble.)

- Connecting cable: No.959149 (1 m)
- Connecting cable: No.959150 (2 m)

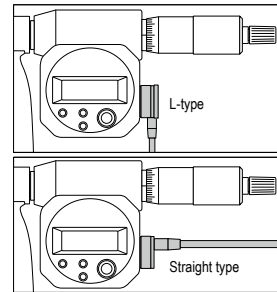

For optional accessories other than the above, see the General Catalog.

14. Off-Site Repairs (Subject to Charge)

Off-site repair (subject to charge) is required in the case of the following malfunctions. Please contact the agent where you purchased the product or a Mitutoyo sales representative.

- Faulty spindle operations
Scratches on the spindle may cause interference while the spindle is retracting, causing faulty operations.
Rust on the spindle may also cause faulty operations.
- Inconsistent measured values
Burr or nicks generated by an impact on the measurement surfaces may affect measurement repeatability.
- Count value errors/faulty operations
If the thimble of this product is retracted too far, the internal sensor will be damaged. This may cause count errors or faulty operations.



Tài liệu được tổng hợp bởi đội ngũ kỹ thuật của **NPOWER**
Bản quyền nội dung thuộc về **Mitutoyo**

Powered by **NAVITECH** | www.navitech.com
www.npower.com.vn