

Length Standard Gauge Blocks

Catalog No. E12014



Mitutoyo

NPOWER
Powered by
NaviTech

Tài liệu được tổng hợp bởi đội ngũ kỹ thuật của **NP**OWER
Bản quyền nội dung thuộc về **Mitutoyo**

Powered by **NAVITECH** | www.navitech.co
www.npower.com.vn

Precision gauge blocks are the primary standards vital to dimensional quality control in the manufacture of parts. Mitutoyo offers a complete selection of gauge blocks available in a choice of rectangular or square, metric or inch and steel or CERA (ceramic) types. Mitutoyo CERA Blocks are some of the finest gauge blocks available anywhere in the world. Steel gauge



blocks are made of a special steel alloy, while CERA Blocks are made of zirconia ceramic. Both types are prepared by highly advanced techniques in the most modern facilities to produce the fine characteristics required of gauge blocks. Tungsten carbide gauge blocks have the advantage of being harder and more wear resistant than steel.



Tài liệu được tổng hợp bởi đội ngũ kỹ thuật của **NPOWER**
Bản quyền nội dung thuộc về **Mitutoyo**

Powered by **NAVITECH** | www.navitech.co
www.npower.com.vn

CONTENTS

Mitutoyo Miyazaki Plant.....	4	Metric/Inch Square Gauge Block Sets	26
Traceability System.....	5	Individual Metric Square Gauge Blocks.....	28
Calibration laboratories worldwide	6	Individual Inch Square Gauge Blocks	29
Accuracies of Mitutoyo Gauge Blocks	8	Square Gauge Block Accessories	30
Features of Gauge Blocks.....	10	Step Master	32
Gauge Blocks with a Calibrated Coefficient of		Custom-made Blocks & Gages	33
Thermal Expansion.....	11	Maintenance Kit for Gauge Blocks	34
ZERO CERA Blocks	11	Ceraston.....	35
Metric/Inch Rectangular Gauge Block Sets	12	Quick Guide to Precision Measuring Instruments.....	36
Micrometer Inspection Gauge Block Sets.....	16	Gauge Block Comparator GBCD-250	38
Individual Metric Rectangular Gauge Blocks	18	Gauge Block Comparator GBCD-100A	38
Individual Inch Rectangular Gauge Blocks	20	Automatic Gauge Block Interferometer GBI.....	39
Rectangular Gauge Block Accessories	22		
Accessories for Gauge Blocks over 100mm	24		

Mitutoyo Miyazaki Plant

The Miyazaki Plant is located in Tano-cho in the Miyazaki Sun Technopolis and began operation as Miyazaki Mitutoyo Precision Co., Ltd. in 1985. The plant is dedicated itself to the production of gauge blocks, the reference of precision measurement, and their applied gages. It prides itself on a reputation for quality and accuracy both in Japan and overseas. Far resting on its laurel, however, the plant is driven by a sense of a mission to continue to "contribute to society through precision measurement. "In October 1985, the Miyazaki Plant began operating, integrating the production of gauge blocks (the length standard and the basis to the traceability of all Mitutoyo products) and the production of Height Master (the gauge block applied instrument). The Miyazaki Plant is now working to further improve the ultra precision machining /engineering expertise which has been accumulated over the years. The development of "CERA Blocks" or ceramic gauge blocks, and digital Height Master, etc. is one of the results of our challenge toward the production of high-tech products.

Company outline

Foundation: October 1985

Number of employees: 85

Total site area: 44,000m²

Floor area of buildings: 7,400m²

Underground measurement laboratories: Total area/161m²

Maintained temperature: 20°C to ±0.5°C

Light wave interferometer: Mitutoyo model, 1000mm (±0.1μm) Zeiss model, 100mm (±0.02μm) Major products

Gauge blocks: Rectangular and square types of gauge blocks. Recently developed are rust free ceramic gauge blocks "CERA Block" which are gaining a strong reputation both in Japan and overseas.

- Output: 100,000 pcs/month

Height master: This is a stack of gauge blocks combined with a micrometer for accurate and efficient setting of any desired height, height masters are also digitalize for further easiness of use.

- Output: 300pcs/month



Traceability system

Traceability system

Mitutoyo has a traceability system made possible through an in-house calibration organization certified by the ISO/IEC 17025 international standard, with length standards directly related to national standards (atomic clock synchronized to UTC and the optical frequency comb) at the highest level.

National standards are mutually recognized by CIPM, and the certified calibration organization is mutually recognized by ILAC, so that the establishment and maintenance of traceability for Mitutoyo products is achieved both in Japan and overseas.



Certificate of JCSS accredited laboratory (Mitutoyo Utsunomiya Measurement Standards Calibration Center)

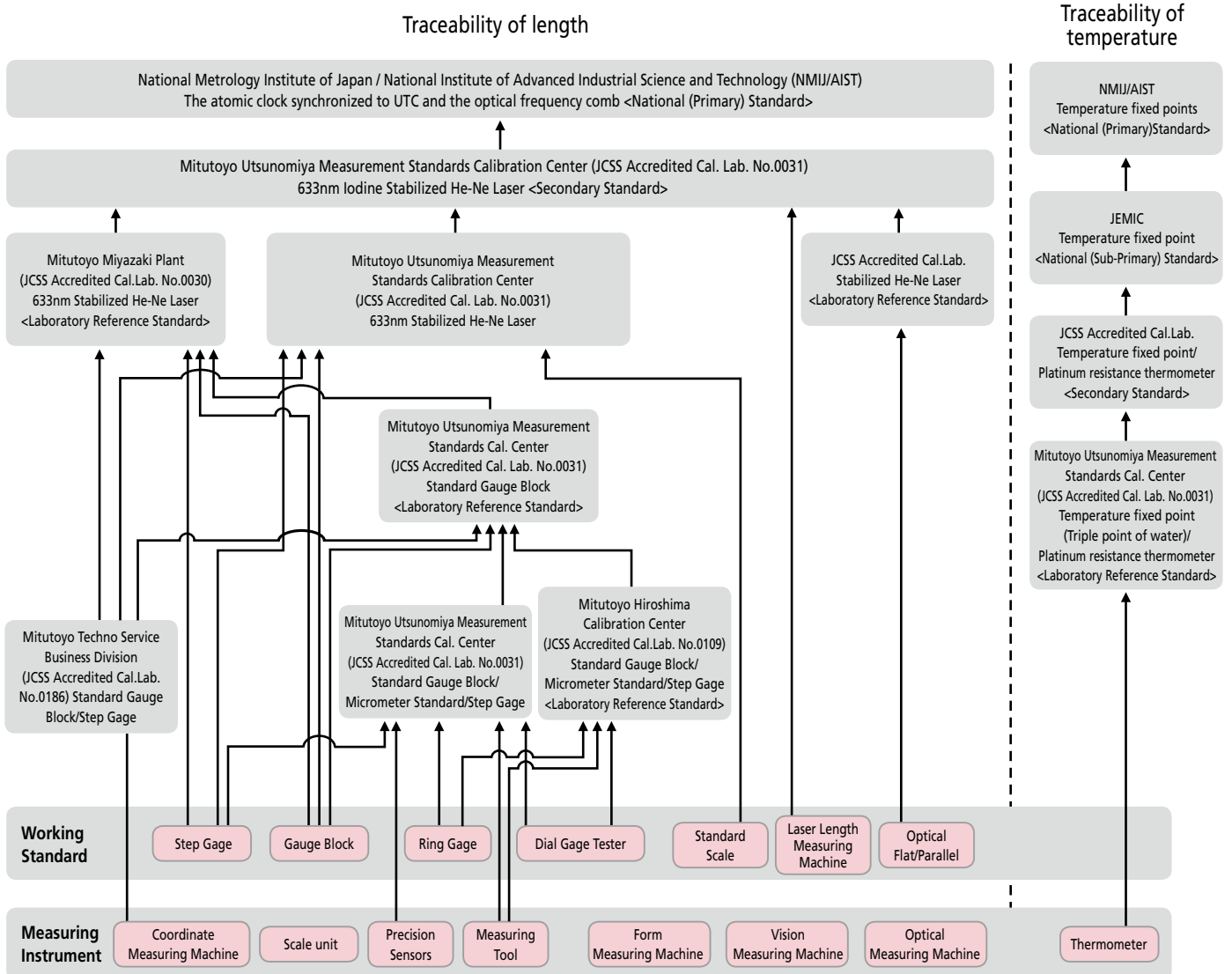

Note: This chart is a simplified representation of Mitutoyo's overall traceability system. Detailed traceability charts are published for each product.

Calibration laboratories worldwide

Calibration laboratories worldwide

Mitutoyo has a system allowing comprehensive support for the calibration of precision measuring products in the global market. In order to provide calibration services on a global basis, Mitutoyo has calibration laboratories that have received ISO/IEC 17025 certification, which is an international standard, from the accredited organizations in each of the countries in which Mitutoyo operates and subsidiaries are located, both in Japan and overseas.

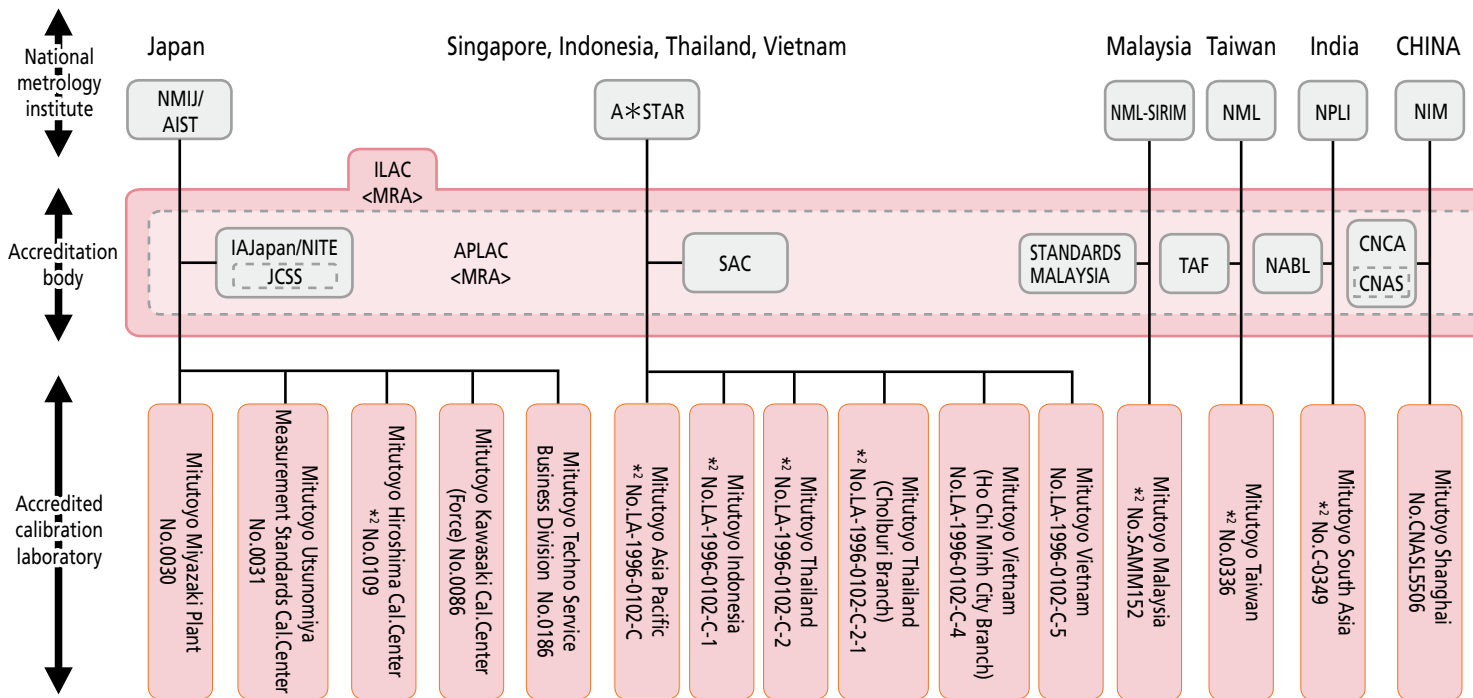

*1 Length and Temperature *2 Length and Hardness No mark is only length

- AIST: National Institute of Advanced Industrial Science and Technology
- NMIJ: National Metrology Institute of Japan
- JCSS: Japan Calibration Service System
- NITE: National Institute of Technology and Evaluation
- IAJapan: International Accreditation Japan
- A*STAR: Agency for Science, Technology and Research, Singapore
- SAC: Singapore Accreditation Council
- NML: National Measurement Laboratory
- TAF: Taiwan Accreditation Foundation
- NML-SIRIM: National Metrology Laboratory, Standards and Industrial Research Institute of Malaysia
- STANDARDS MALAYSIA: Department of Standards Malaysia
- NIST: National Institute of Standards and Technology
- NIM: National Institute of Metrology, China
- CNCA: Certification and Accreditation Administration of the People's Republic of China
- CNAS: China National Accreditation Service
- A2LA: American Association for Laboratory Accreditation
- NRC-INMS: National Research Council of Canada-Institute for National Measurement Standards
- CLAS: Calibration Laboratory Assessment Service
- SCC: Standards Council of Canada
- CENAM: Centro Nacional de Metrología
- EMA: Entidad Mexicana de Acreditación, a.c.
- UKAS: United Kingdom Accreditation Service

- NMI: Nederlands Meetinstituut
- RvA: Raad voor Accreditatie
- PTB: Physikalisch-Technische Bundesanstalt
- DAkkS: Deutsche Akkreditierungsstelle GmbH
- METAS: The Swiss Federal Office of Metrology and Accreditation
- SAS: Swiss Accreditation Service
- IMGC: Istituto di Metrologia " GUSTAVO COLONNETTI "
- ACCREDIA: L'NTE ITALIANO DI ACCREDITAMENTO
- SP: Swedish National Testing and Research Institute
- SWEDAC: Swedish Board for Accreditation and Conformity Assessment
- INMETRO: Instituto Nacional de Metrologia Normalizacao e Qualidade Industrial
- RBC: Rede Brasileira de Calibracao
- INTI: Instituto Nacional de Tecnologia Industrial
- OAA: Organismo Argentino de Acreditaci
- NPL: National Physical Laboratory
- NPLI: National Physical Laboratory of India
- NABL: National Accreditation Board for Testing and Calibration Laboratories
- (ILAC): International Laboratory Accreditation Cooperation
- (APLAC): Asia-Pacific Laboratory Accreditation Cooperation
- (EA): European Accreditation Cooperation
- (MRA): Mutual Recognition Arrangement
- #: Accreditation No.

The above is information of domestic and international bases where Mitutoyo provides the accredited calibration service having received ISO/IEC 17025 certification.

Tài liệu được tổng hợp bởi đội ngũ kỹ thuật của **NPOWER**
Bản quyền nội dung thuộc về **Mitutoyo**

Powered by **NAVITECH** | www.navitech.co
www.npower.com.vn

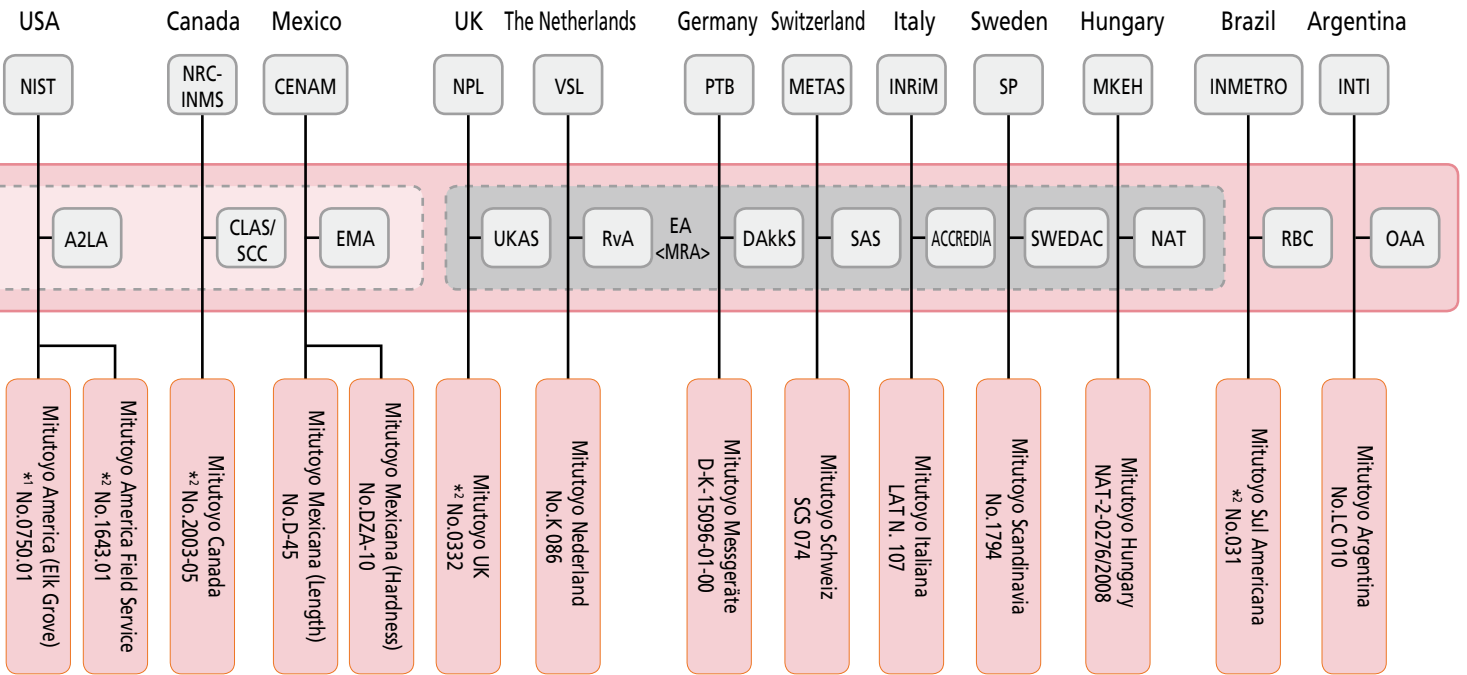

Accuracies of Mitutoyo Gauge Blocks

As a world-leading precision measuring equipment manufacturer, Mitutoyo is certified by the Japanese government as an accredited calibration laboratory, which means that the accuracy of its gauge blocks is guaranteed through traceability to the Metrology Management Center of the National Institute of Advanced Industrial Science and Technology (AIST).

ACCURACY SPECIFICATIONS: JIS B 7506-2004 (JAPAN)

(at 20°C)

Nominal length (mm)	Grade K		Grade 0	
	Limit deviation of length at any point	Tolerance for the variation in length	Limit deviation of length at any point	Tolerance for the variation in length
from 0.5 up to 10	±0.20µm	0.05µm	±0.12µm	0.10µm
over 10 up to 25	±0.30µm	0.05µm	±0.14µm	0.10µm
over 25 up to 50	±0.40µm	0.06µm	±0.20µm	0.10µm
over 50 up to 75	±0.50µm	0.06µm	±0.25µm	0.12µm
over 75 up to 100	±0.60µm	0.07µm	±0.30µm	0.12µm
over 100 up to 150	±0.80µm	0.08µm	±0.40µm	0.14µm
over 150 up to 200	±1.00µm	0.09µm	±0.50µm	0.16µm
over 200 up to 250	±1.20µm	0.10µm	±0.60µm	0.16µm
over 250 up to 300	±1.40µm	0.10µm	±0.70µm	0.18µm
over 300 up to 400	±1.80µm	0.12µm	±0.90µm	0.20µm
over 400 up to 500	±2.20µm	0.14µm	±1.10µm	0.25µm
over 500 up to 600	±2.60µm	0.16µm	±1.30µm	0.25µm
over 600 up to 700	±3.00µm	0.18µm	±1.50µm	0.30µm
over 700 up to 800	±3.40µm	0.20µm	±1.70µm	0.30µm
over 800 up to 900	±3.80µm	0.20µm	±1.90µm	0.35µm
over 900 up to 1000	±4.20µm	0.25µm	±2.00µm	0.40µm

Nominal length (mm)	Grade 1		Grade 2	
	Limit deviation of length at any point	Tolerance for the variation in length	Limit deviation of length at any point	Tolerance for the variation in length
from 0.5 up to 10	±0.20µm	0.16µm	±0.45µm	0.30µm
over 10 up to 25	±0.30µm	0.16µm	±0.60µm	0.30µm
over 25 up to 50	±0.40µm	0.18µm	±0.80µm	0.30µm
over 50 up to 75	±0.50µm	0.18µm	±1.00µm	0.35µm
over 75 up to 100	±0.60µm	0.20µm	±1.20µm	0.35µm
over 100 up to 150	±0.80µm	0.20µm	±1.60µm	0.40µm
over 150 up to 200	±1.00µm	0.25µm	±2.00µm	0.40µm
over 200 up to 250	±1.20µm	0.25µm	±2.40µm	0.45µm
over 250 up to 300	±1.40µm	0.25µm	±2.80µm	0.50µm
over 300 up to 400	±1.80µm	0.30µm	±3.60µm	0.50µm
over 400 up to 500	±2.20µm	0.35µm	±4.40µm	0.60µm
over 500 up to 600	±2.60µm	0.40µm	±5.00µm	0.70µm
over 600 up to 700	±3.00µm	0.45µm	±6.00µm	0.70µm
over 700 up to 800	±3.40µm	0.50µm	±6.50µm	0.80µm
over 800 up to 900	±3.80µm	0.50µm	±7.50µm	0.90µm
over 900 up to 1000	±4.20µm	0.60µm	±8.00µm	1.00µm

ACCURACY SPECIFICATIONS: BS 4311: Part 1: 1993 (UK)

(at 20°C)

Nominal length (inch)	Grade K			Grade 0		
	Tolerance on deviation of measured central length	Parallelism	Flatness	Tolerance on deviation of measured central length	Parallelism	Flatness
over 0 up to 0.4	±5µin	2µin	2µin	±5µin	4µin	4µin
over 0.4 up to 1	±6µin	2µin	2µin	±6µin	4µin	4µin
over 1 up to 2	±8µin	3µin	2µin	±8µin	4µin	4µin
over 2 up to 3	±10µin	3µin	2µin	±10µin	5µin	4µin
over 3 up to 4	±12µin	3µin	2µin	±12µin	5µin	4µin

Nominal length (inch)	Grade 1			Grade 2		
	Tolerance on deviation of measured central length	Parallelism	Flatness	Tolerance on deviation of measured central length	Parallelism	Flatness
over 0 up to 0.4	±10µin	6µin	6µin	±20µin	12µin	10µin
over 0.4 up to 1	±12µin	6µin	6µin	±25µin	12µin	10µin
over 1 up to 2	±15µin	7µin	6µin	±30µin	12µin	10µin
over 2 up to 3	±20µin	7µin	6µin	±40µin	14µin	10µin
over 3 up to 4	±25µin	8µin	6µin	±50µin	14µin	10µin

(at 20°C)

Nominal length (mm)	Grade K			Grade 0		
	Tolerance on deviation of measured central length	Parallelism	Flatness	Tolerance on deviation of measured central length	Parallelism	Flatness
over 0 up to 10	±0.12µm	0.05µm	0.05µm	±0.12µm	0.10µm	0.10µm
over 10 up to 25	±0.15µm	0.05µm	0.05µm	±0.15µm	0.10µm	0.10µm
over 25 up to 50	±0.20µm	0.06µm	0.05µm	±0.20µm	0.10µm	0.10µm
over 50 up to 75	±0.25µm	0.06µm	0.05µm	±0.25µm	0.12µm	0.10µm
over 75 up to 100	±0.30µm	0.07µm	0.05µm	±0.30µm	0.12µm	0.10µm

Nominal length (mm)	Grade 1			Grade 2		
	Tolerance on deviation of measured central length	Parallelism	Flatness	Tolerance on deviation of measured central length	Parallelism	Flatness
over 0 up to 10	±0.25µm	0.16µm	0.15µm	±0.50µm	0.30µm	0.25µm
over 10 up to 25	±0.30µm	0.16µm	0.15µm	±0.60µm	0.30µm	0.25µm
over 25 up to 50	±0.40µm	0.18µm	0.15µm	±0.80µm	0.30µm	0.25µm
over 50 up to 75	±0.50µm	0.18µm	0.15µm	±1.00µm	0.35µm	0.25µm
over 75 up to 100	±0.60µm	0.20µm	0.15µm	±1.20µm	0.35µm	0.25µm

ACCURACY SPECIFICATIONS: ASME B89.1.9-2002 (USA)

(at 20°C)

Nominal length (inch)	Grade K		Grade 00		Grade 0		Grade 1		Grade 2	
	Limit deviations of length at any point	Tolerance for the variation of length in length	Limit deviations of length at any point	Tolerance for the variation of length in length	Limit deviations of length at any point	Tolerance for the variation of length in length	Limit deviations of length at any point	Tolerance for the variation of length in length	Limit deviations of length at any point	Tolerance for the variation of length in length
up to .05	±12µin	2µin	±4µin	2µin	±6µin	4µin	±12µin	6µin	±24µin	12µin
over .05 up to .4	±10µin	2µin	±3µin	2µin	±5µin	4µin	±8µin	6µin	±18µin	12µin
over .45 up to 1	±12µin	2µin	±3µin	2µin	±6µin	4µin	±12µin	6µin	±24µin	12µin
over 1 up to 2	±16µin	2µin	±4µin	2µin	±8µin	4µin	±16µin	6µin	±32µin	12µin
over 2 up to 3	±20µin	2µin	±5µin	3µin	±10µin	4µin	±20µin	6µin	±40µin	14µin
over 3 up to 4	±24µin	3µin	±6µin	3µin	±12µin	5µin	±24µin	8µin	±48µin	14µin
over 4 up to 5	±32µin	3µin	±8µin	3µin	±16µin	5µin	±32µin	8µin	±64µin	16µin
over 5 up to 6	±32µin	3µin	±8µin	3µin	±16µin	5µin	±32µin	8µin	±64µin	16µin
over 6 up to 7	±40µin	4µin	±10µin	4µin	±20µin	6µin	±40µin	10µin	±80µin	16µin
over 7 up to 8	±40µin	4µin	±10µin	4µin	±20µin	6µin	±40µin	10µin	±80µin	16µin
over 8 up to 10	±48µin	4µin	±12µin	4µin	±24µin	6µin	±48µin	10µin	±104µin	18µin
over 10 up to 12	±56µin	4µin	±14µin	4µin	±28µin	7µin	±56µin	10µin	±112µin	20µin
over 12 up to 16	±72µin	5µin	±18µin	5µin	±36µin	8µin	±72µin	12µin	±144µin	20µin
over 16 up to 20	±88µin	6µin	±20µin	6µin	±44µin	10µin	±88µin	14µin	±176µin	24µin
over 20 up to 24	±104µin	6µin	±25µin	6µin	±52µin	10µin	±104µin	16µin	±200µin	28µin
over 24 up to 28	±120µin	7µin	±30µin	7µin	±60µin	12µin	±120µin	18µin	±240µin	28µin
over 28 up to 32	±136µin	8µin	±34µin	8µin	±68µin	12µin	±136µin	20µin	±260µin	32µin
over 32 up to 36	±152µin	8µin	±38µin	8µin	±76µin	14µin	±152µin	20µin	±300µin	36µin
over 36 up to 40	±160µin	10µin	±40µin	10µin	±80µin	16µin	±168µin	24µin	±320µin	40µin

Nominal length (mm)	Grade K		Grade 00		Grade 0		Grade 1		Grade 2	
	Limit deviations of length at any point	Tolerance for the variation of length in length	Limit deviations of length at any point	Tolerance for the variation of length in length	Limit deviations of length at any point	Tolerance for the variation of length in length	Limit deviations of length at any point	Tolerance for the variation of length in length	Limit deviations of length at any point	Tolerance for the variation of length in length
up to 0.5	±0.30µm	0.05µm	±0.10µm	0.05µm	±0.14µm	0.10µm	±0.30µm	0.16µm	±0.60µm	0.30µm
over 0.5 up to 10	±0.20µm	0.05µm	±0.07µm	0.05µm	±0.12µm	0.10µm	±0.20µm	0.16µm	±0.45µm	0.30µm
over 10 up to 25	±0.30µm	0.05µm	±0.07µm	0.05µm	±0.14µm	0.10µm	±0.30µm	0.16µm	±0.60µm	0.30µm
over 25 up to 50	±0.40µm	0.06µm	±0.10µm	0.06µm	±0.20µm	0.10µm	±0.40µm	0.18µm	±0.80µm	0.30µm
over 50 up to 75	±0.50µm	0.06µm	±0.12µm	0.06µm	±0.25µm	0.12µm	±0.50µm	0.18µm	±1.00µm	0.35µm
over 75 up to 100	±0.60µm	0.07µm	±0.15µm	0.07µm	±0.30µm	0.12µm	±0.60µm	0.20µm	±1.20µm	0.35µm
over 100 up to 150	±0.80µm	0.08µm	±0.20µm	0.08µm	±0.40µm	0.14µm	±0.80µm	0.20µm	±1.60µm	0.40µm
over 150 up to 200	±1.00µm	0.09µm	±0.25µm	0.09µm	±0.50µm	0.16µm	±1.00µm	0.25µm	±2.00µm	0.40µm
over 200 up to 250	±1.20µm	0.10µm	±0.30µm	0.10µm	±0.60µm	0.16µm	±1.20µm	0.25µm	±2.40µm	0.45µm
over 250 up to 300	±1.40µm	0.10µm	±0.35µm	0.10µm	±0.70µm	0.18µm	±1.40µm	0.25µm	±2.80µm	0.50µm
over 300 up to 400	±1.80µm	0.12µm	±0.45µm	0.12µm	±0.90µm	0.20µm	±1.80µm	0.30µm	±3.60µm	0.50µm
over 400 up to 500	±2.20µm	0.14µm	±0.50µm	0.14µm	±1.10µm	0.25µm	±2.20µm	0.35µm	±4.40µm	0.60µm
over 500 up to 600	±2.60µm	0.16µm	±0.65µm	0.16µm	±1.30µm	0.25µm	±2.60µm	0.40µm	±5.00µm	0.70µm
over 600 up to 700	±3.00µm	0.18µm	±0.75µm	0.18µm	±1.50µm	0.30µm	±3.00µm	0.45µm	±6.00µm	0.70µm
over 700 up to 800	±3.40µm	0.20µm	±0.85µm	0.20µm	±1.70µm	0.30µm	±3.40µm	0.50µm	±6.50µm	0.80µm
over 800 up to 900	±3.80µm	0.20µm	±0.95µm	0.20µm	±1.90µm	0.35µm	±3.80µm	0.50µm	±7.50µm	0.90µm
over 900 up to 1000	±4.20µm	0.25µm	±1.00µm	0.25µm	±2.00µm	0.40µm	±4.20µm	0.60µm	±8.00µm	1.00µm

Grade and Application

The following table can be used to select the gauge block grade according to usage (specified by DIN861, BS4311, and JIS B 7506).

	Applications	Grade
Workshop use	• Mounting tools and cutters	2
	• Manufacturing gages • Calibrating instruments	1 or 2
Inspection use	• Inspecting mechanical parts, tools, etc.	1 or 2
	• Checking the accuracy of gages • Calibrating instruments	0 or 1
Calibration use	• Checking the accuracy of gauge blocks for workshop • Checking the accuracy of gauge blocks for inspection • Checking the accuracy of instruments	K or 0
	• Checking the accuracy of gauge blocks for calibration • For academic research	K

Grade and Application

Grade 2:

These gauge blocks are intended for shop floor use to set and calibrate fixtures as well as precision instruments.

Grade 1:

This grade is used within an inspection area to verify the accuracy of plug and snap gages as well as for setting electronic measuring devices.

Grade 0:

These higher accuracy gauges are intended for use within a controlled environment by skilled inspection staff. Mainly used as reference standards for setting high precision measuring equipment and for the calibration of lower grade gauge blocks.

Grade K:

Gauge blocks of this accuracy are intended for use within a temperature controlled inspection room or calibration laboratory. They should be used as masters with certificates against other gauge blocks which are calibrated by comparison.

Constructing a Gauge Block Stack

The following points should be noted when constructing a gauge block stack:

1. Use as few gauge blocks as possible to obtain the required length by selecting thick blocks wherever possible.
2. Select the block for the least significant digit first, then work back through the more significant digits until the required length is attained.
3. There are multiple combinations for the integer part of a length. To prevent wear as much as possible, do not always use the same gauge blocks.

Example: Required length = 45.6785mm

• For a 1mm-based gauge block set (112 pcs.)

$$\begin{array}{r}
 1.0005 \\
 1.008 \\
 1.17 \\
 17.5 \\
 +) 25 \\
 \hline
 45.6785\text{mm}
 \end{array}$$

• For a 2mm-based gauge block set (112 pcs.)

$$\begin{array}{r}
 2.0005 \\
 2.008 \\
 2.17 \\
 14.5 \\
 +) 25 \\
 \hline
 45.6785\text{mm}
 \end{array}$$

* Regarding the method for wringing, refer to "Quick Guide to Precision Measuring Instruments" on page E-33.

Mitutoyo Gauge Blocks and Inspection Certificates

A Certificate of Inspection is furnished with all Mitutoyo gauge blocks with a serial number on the box (in the case of sets) and an identification number on each block. The deviation of each block from nominal length, at the time of inspection, is stated. For this inspection, each gauge block is measured relative to the upper level master using a gauge block comparator. Grade K gauge blocks are measured by a primary measurement method using an interferometer.

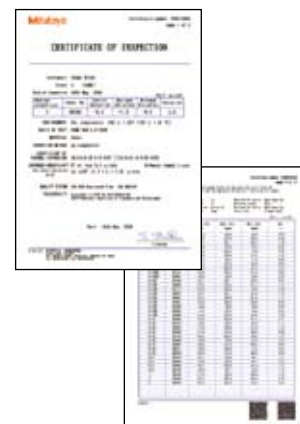

Selecting Gauge Blocks

- Select gauge blocks in accordance with the combination range required. If a large length is required, add a long block set.
- Select gauge blocks in accordance with the minimum length step required. Add wear block sets if necessary.
- If a set containing a large number of gauge blocks is selected, the number of combination gauge blocks required for a length is reduced and the number of combinations is increased. The accuracy will be retained and damage will be reduced.
- The specific gauge block set for micrometer inspection and caliper inspection is available.
- If using only one length repeatedly, it is a good idea to purchase discrete gauge blocks.
- The 2mm-based gauge blocks, which take the base of the minimum length step as 2mm, are easy to handle and will not warp, as compared to the 1mm-based gauge blocks.

Features of Gauge Blocks

Mitutoyo offers 3 types of gauge block for use as length standards: rectangular steel, rectangular ceramic (CERA Blocks) and square steel gauge blocks. In addition, rectangular and square protection blocks (1mm and 2mm for each) are available in tungsten carbide. Mitutoyo gauge blocks are recognized to be of the highest quality both here in Japan and abroad, and are available in various grades to meet every need in respect of working conditions, environment and application.

Wringing

Lapping measuring surfaces is one of Mitutoyo's specialties. Our advanced technique, developed over more than half a century, enables us to achieve the optimum flatness and surface finish needed for gauge blocks and thus maximize the wringing force.

Abrasion Resistance and Dimensional Stability of Steel Blocks

High-carbon high-chrome steel is employed to satisfy a variety of the material characteristics required for gauge blocks. Our advanced heat treatment technology for steel blocks, which involves repeated temperature cycling, simultaneously achieves excellent abrasion resistance and minimizes any change in length over time.

Features of Mitutoyo CERA Blocks

CERA blocks are made of a ceramic material with a superior surface finish, created by Mitutoyo's ultra-precision machining techniques, that provides a premium quality block with significant advantages:

1. Corrosion Resistant

Anti-corrosion treatment is not required when handled normally (i.e. with fingers), resulting in simple maintenance and storage.

2. No Burrs Caused by Accidental Mishandling

Since the CERA Block is very hard, it will not scratch easily and is highly resistant to burrs. If a burr is formed, it can easily be removed with a ceramic deburring stone (Ceraston).

3. Abrasion Resistant

CERA Blocks have 10 times the abrasion resistance of steel gauge blocks.

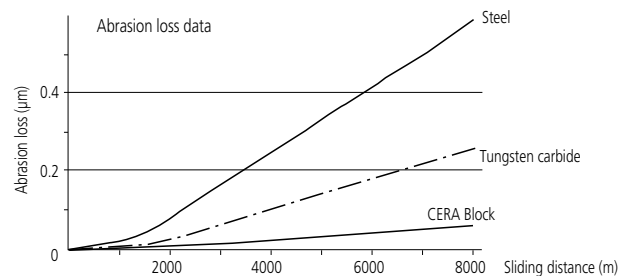

4. Dimensionally Stable

CERA Blocks are free from dimensional change over time.

5. Clearly Marked Sizes

Black characters, indicating the nominal length, are inscribed by laser and are clearly visible against the white surface of the block.

6. Non-magnetic Nature Prevents Steel Swarf Contamination

7. High Wringing Force

Superior flatness and surface finish provides maximum wringing force.



8. Superior Material Characteristics of CERA Block

Property	Material	CERA Block (ZrO ₂)	Steel (Fe)	Tungsten Carbide (WC-Co)
Hardness (HV)		1350	800	1650
Coefficient of thermal expansion (10 ⁻⁶ /K)		9.3±0.5	10.8±0.5	5.5±1.0
Flexural strength by 3-point bending (MPa)		1270	1960	1960
Fracture toughness K1c (MPa•m ^{1/2})		7	120	12
Young's modulus x10 ⁻⁴ (MPa)		20.6	20.6	61.8
Poisson's ratio		0.3	0.3	0.2
Specific gravity		6.0	7.8	14.8
Thermal conductivity (W/m•k)		2.9	54.4	79.5

* Ceramics have the advantage of a slow response to temperature changes due to the low thermal conductivity. However, caution is required when using CERA blocks in the environment of severe temperature change.

9. Closest Expansion Coefficient to Steel

The thermal expansion coefficient of a CERA Block is quite similar to that of a steel gauge block.

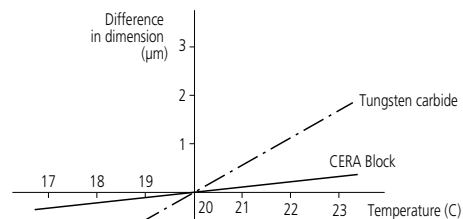

Differences in size between alternative gauge block materials and steel that are obtained when measuring over a length of 100mm at each temperature.

10. Highly Resistant to Dropping and Impact Damage

The CERA Block material is one of the toughest ceramics. It is extremely difficult to crack a CERA block in normal use.

Gauge Blocks with a Calibrated Coefficient of Thermal Expansion

- Mitutoyo offers top-level gauge blocks (steel and ceramic) which are superior to K class blocks, with their quality supported by Mitutoyo's best technologies.
- Features an accurately calibrated thermal expansion coefficient measured with a proprietary double-faced interferometer (DFI).
- Each gauge block is calibrated for length on a highly accurate gauge block interferometer (GBI) system.
- Available as rectangular gauge blocks in the range 100 to 500mm.



SPECIFICATIONS

Metric Blocks with CTE			Inch Blocks with CTE		
Order No. (steel)*	Order No. (CERA)*	Length (mm)	Order No. (steel)*	Order No. (CERA)*	Length (inch)
611681	613681	100	611204	613204	4
611802	613802	125	611205	613205	5
611803	613803	150	611206	613206	6
611804	613804	175	611207	613207	7
611682	613682	200	611208	613208	8
611805	613805	250	611222	613222	10
611683	613683	300	611223	613223	12
611684	613684	400	611224	613224	16
611685	613685	500	611225	613225	20

Grade: K class in JIS/ASME/ISO
 Uncertainty of thermal expansion coefficient: $0.035 \times 10^{-6}/K$ (k = 2)
 Uncertainty of length measurement: 30nm (k = 2), for 100mm block

* An inspection certificate and a JCSS calibration certificate are supplied as standard.
 A calibration report and a calibration certificate for the thermal expansion coefficient are also supplied as standard.

* Suffix Number (-nnn) for Selecting Standard Required

ISO/DIN/JIS			
Suffix No.	Grade	Inspection Certificate	Calibration Certificate
-01B	K	○	○

ASME			
Suffix No.	Grade	Inspection Certificate	Calibration Certificate
-51B	K	○	○

BS			
Suffix No.	Grade	Inspection Certificate	Calibration Certificate
-11B	K	○	○

* Only for 100mm type

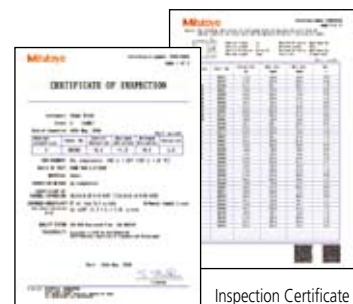

Inspection Certificate

ZERO CERA Blocks

- Thermal expansion in the temperature range $20 \pm 1^\circ C$ less than 1/500 that of steel ($0 \pm 0.02 \times 10^{-6}/K$ ($20^\circ C$))
- Almost no secular change both in dimension and coefficient of thermal expansion
- Complementary ultra-low thermal expansion and high specific rigidity (Young's modulus/specific gravity)



SPECIFICATIONS

Metric Blocks			
Order No.			Length (mm)
JIS/ISO/DIN	BS	ASME	
617673-016	617673-116	617673-516	30
617675-016	617675-116	617675-516	50
617681-016	617681-116	617681-516	100
617682-016	617682-116	617682-516	200
617683-016	617683-116	617683-516	300
617684-016	617684-116	617684-516	400
617685-016	617685-116	617685-516	500
617840-016	617840-116	617840-516	600
617841-016	617841-116	617841-516	700
617843-016	617843-116	617843-516	800
617844-016	617844-116	617844-516	900
617845-016	617845-116	617845-516	1000
516-771-60	516-771-61	516-771-66	Above set

Metric/Inch Rectangular Gauge Block Sets

Mitutoyo provides a wide selection of boxed sets of gauge blocks to meet the various needs of industry. Selecting the best set, or sets, to acquire usually depends on the accuracy required by the target applications, the level of convenience desired (larger sets offer more combination possibilities) and the environmental conditions in which they will be used.

Steel 1mm Base Block Sets



Steel 112-block set



Steel 103-block set



Steel 76-block set



Steel 56-block set



Steel 47-block set



Steel 46-block set



Steel 34-block set



Steel 32-block set

Steel 0.001mm Step Block Sets



Steel 9-block set



Steel 9-block set



Steel 18-block set

Steel Long Block Sets



Steel 8-block set

Steel Wear Block Sets



Steel 2-block set

Steel Thin Block Sets



Steel 9-block set

Note: Details of the contents of any particular set are given on page E-14.



Tài liệu được tổng hợp bởi đội ngũ kỹ thuật của **NPOWER**
Bản quyền nội dung thuộc về **Mitutoyo**

Powered by **NAVITECH** | www.navitech.co
www.npower.com.vn

CERA 1mm Base Block Sets



CERA 112-block set



CERA 103-block set



CERA 76-block set



CERA 56-block set



CERA 47-block set



CERA 46-block set



CERA 34-block set



CERA 32-block set

CERA 0.001mm Step Block Sets



CERA 9-block set



CERA 9-block set



CERA 18-block set

CERA Long Block Sets



CERA 8-block set

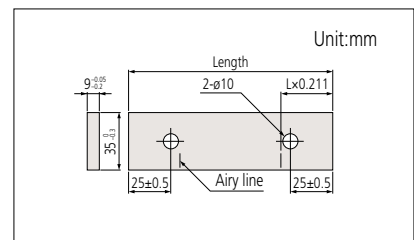

CERA Wear Block Sets



CERA 2-block set

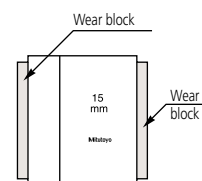

Note: Details of the contents of any particular set are given on page E-15.

*** Suffix Number (n) for Selecting Standard and Certificate Provided**

ISO/DIN/JIS		
Suffix No.	Inspection Certificate	Calibration Certificate
		JCSS
1	○	—
6	○	○

Suffix No. 1: Not available for Grade K sets.

ASME		
Suffix No.	Inspection Certificate	Calibration Certificate
		JCSS
1	○	—
6	○	○

Suffix No. 1: Not available for Grade K sets.
Suffix No. 6: Only for Grade K sets.

BS		
Suffix No.	Inspection Certificate	Calibration Certificate
		JCSS
1	○	—
6	○	○

Suffix No. 1: Not available for Grade K sets.
Suffix No. 6: Only for Grade K sets.

Inspection Certificate



SPECIFICATIONS

* Refer to "Classification of Gauge Blocks by Shape" on page 37 for sizes and forms, and "Accuracies of Mitutoyo Gauge Blocks" on page 8 and 9 for accuracy.

1mm Base Block Sets								
Blocks per set	Order No.		Standard / grade available and Suffix No.*			Blocks included in set		
	Steel	CERA	ISO/DIN/JIS	ASME	BS	Size	Step	Qty.
122	—	—	—	—	—	1.0005	—	1
	516-596	—	K: -n0	—	—	1.001 - 1.009	0.001	9
	516-597	—	0: -n0	—	—	1.01 - 1.49	0.01	49
	516-598	—	1: -n0	—	—	1.6 - 1.9	0.1	4
112	516-531	516-541	—	K: -n6	—	1.0005	—	1
	516-937	516-337	K: -n0	00: -n6	K: -n1	1.001 - 1.009	0.001	9
	516-938	516-338	0: -n0	0: -n6	0: -n1	1.01 - 1.49	0.01	49
	516-939	516-339	1: -n0	1: -n6	1: -n1	0.5 - 24.5	0.5	49
103	516-533	516-542	—	K: -n6	—	1.005	—	1
	516-941	516-341	K: -n0	00: -n6	K: -n1	1.01 - 1.49	0.01	49
	516-942	516-342	0: -n0	0: -n6	0: -n1	0.5 - 24.5	0.5	49
	516-943	516-343	1: -n0	1: -n6	1: -n1	25 - 100	25	4
88	—	—	—	—	—	1.0005	—	1
	516-969	516-369	—	—	K: -n1	1.001 - 1.009	0.001	9
	516-970	516-370	0: -n0	—	0: -n1	1.01 - 1.49	0.01	49
	516-971	516-371	1: -n0	—	1: -n1	0.5 - 9.5	0.5	19
87	516-535	515-543	—	K: -n6	—	1.001 - 1.009	0.001	9
	516-945	516-345	K: -n0	00: -n6	K: -n1	1.01 - 1.49	0.01	49
	516-946	516-346	0: -n0	0: -n6	0: -n1	0.5 - 9.5	0.5	19
	516-947	516-347	1: -n0	1: -n6	1: -n1	10 - 100	10	10
76	—	—	—	—	—	1.005	—	1
	516-949	516-349	K: -n0	—	—	1.01 - 1.49	0.01	49
	516-950	516-350	0: -n0	—	—	0.5 - 9.5	0.5	19
	516-951	516-351	1: -n0	—	—	10 - 40	10	4
56	516-536	516-544	—	K: -n6	—	0.5	—	1
	516-953	516-353	K: -n0	00: -n6	—	1.001 - 1.009	0.001	9
	516-954	516-354	0: -n0	0: -n6	—	1.01 - 1.09	0.01	9
	516-955	516-355	1: -n0	1: -n6	—	1.1 - 1.9	0.1	9
47	516-537	516-545	—	K: -n6	—	1.005	—	1
	516-957	516-357	K: -n0	00: -n6	—	1.01 - 1.09	0.01	9
	516-958	516-358	0: -n0	0: -n6	—	1.1 - 1.9	0.1	9
	516-959	516-359	1: -n0	1: -n6	—	1 - 24	1	24
47	—	—	—	—	—	1.005	—	1
	516-961	516-361	K: -n0	—	K: -n1	1.01 - 1.19	0.01	19
	516-962	516-362	0: -n0	—	0: -n1	1.2 - 1.9	0.1	8
	516-963	516-363	1: -n0	—	1: -n1	1 - 9	1	9
46	—	—	—	—	—	1.001 - 1.009	0.001	9
	516-994	516-394	K: -n0	—	—	1.01 - 1.09	0.01	9
	516-995	516-395	0: -n0	—	—	1.1 - 1.9	0.1	9
	516-996	516-396	1: -n0	—	—	1 - 9	1	9
34	—	—	—	—	—	1.0005	—	1
	516-128	516-178	K: -n0	—	K: -n1	1.001 - 1.009	0.001	9
	516-129	516-179	0: -n0	—	0: -n1	1.01 - 1.09	0.01	9
	516-130	516-180	1: -n0	—	1: -n1	1.1 - 1.9	0.1	9
32	—	—	—	—	—	1.005	—	1
	516-965	516-365	K: -n0	—	K: -n1	1.01 - 1.09	0.01	9
	516-966	516-366	0: -n0	—	0: -n1	1.1 - 1.9	0.1	9
	516-967	516-367	1: -n0	—	1: -n1	1 - 9	1	9
9	—	—	—	—	—	10 - 30	10	3
	516-990	—	0: -n0	—	—	0.10 - 0.50	0.05	9
	516-991	—	1: -n0	—	—	—	—	—
	516-992	—	2: -n0	—	—	—	—	—

Thin Block Sets								
Blocks per set	Order No.		Standard / grade available and Suffix No.*			Blocks included in set		
	Steel	CERA	ISO/DIN/JIS	ASME	BS	Size	Step	Qty.
9	516-990	—	0: -n0	—	—	0.10 - 0.50	0.05	9
	516-991	—	1: -n0	—	—	—	—	—
	516-992	—	2: -n0	—	—	—	—	—



Tài liệu được tổng hợp bởi đội ngũ kỹ thuật của **NPOWER**
Bản quyền nội dung thuộc về **Mitutoyo**

Powered by **NAVITECH** | www.navitech.co
www.npower.com.vn

SPECIFICATIONS

* Refer to "Classification of Gauge Blocks by Shape" on page 37 for sizes and forms, and "Accuracies of Mitutoyo Gauge Blocks" on page 8 and 9 for accuracy.

0.001mm Step Block Set								
Blocks per set	Order No.		Standard / grade available and Suffix No.*			Blocks included in set		
	Steel	CERA	ISO/DIN/JIS	ASME	BS	Size	Step	Qty.
18	516-973	516-373	K: -n0	—	—	0.991 - 0.999	0.001	9
	516-974	516-374	0: -n0	—	—			
	516-975	516-375	1: -n0	—	—	1.001 - 1.009	0.001	9
	516-976	516-376	2: -n0	—	—			
9	516-981	516-381	K: -n0	—	K: -n1	1.001 - 1.009	0.001	9
	516-982	516-382	0: -n0	—	0: -n1			
	516-983	516-383	1: -n0	—	1: -n1	0.991 - 0.999	0.001	9
	516-984	516-384	2: -n0	—	2: -n1			
9	516-985	516-385	K: -n0	—	—	0.991 - 0.999	0.001	9
	516-986	516-386	0: -n0	—	—			
	516-987	516-387	1: -n0	—	—	0.991 - 0.999	0.001	9
	516-988	516-388	2: -n0	—	—			

Long Block Sets								
Blocks per set	Order No.		Standard / grade available and Suffix No.*			Blocks included in set		
	Steel	CERA	ISO/DIN/JIS	ASME	BS	Size	Step	Qty.
8	516-540	516-546	—	K: -n6	—	125 - 175	25	3
	516-701	516-731	K: -n0	00: -n6	—	200 - 250	50	2
	516-702	516-732	0: -n0	0: -n6	—	300 - 500	100	3
	516-703	516-733	1: -n0	1: -n6	—			
	516-704	516-734	2: -n0	2: -n6	—			
	516-704	516-734	2: -n0	2: -n6	—			

Wear Block Sets								
Blocks per set	Order No.		Standard / grade available and Suffix No.*			Blocks included in set		
	Carbide	CERA	ISO/DIN/JIS	ASME	BS	Size	Step	Qty.
2	516-807	516-832	0: -n0	0: -n6	—	1		2
	516-806	516-833	1: -n0	1: -n6	—			
2	516-803	516-830	0: -n0	0: -n6	—	2		2
	516-802	516-831	1: -n0	1: -n6	—			

Inch Block Sets									
Blocks per set	Order No.		Standard / grade available and Suffix No.*			Blocks included in set			
	Steel	CERA	ISO/DIN/JIS	ASME	BS	Size	Step	Qty.	
82	516-548	516-556	—	K: -n6	—	.10005		1	
	516-905	516-305	—	00: -n6	—	.1001 - .1009		.0001	9
	516-906	516-306	—	0: -n6	0: -n1	.101 - .149		.001	49
	516-907	516-307	—	1: -n6	1: -n1	.05 - .95		.05	19
	516-908	516-308	—	2: -n6	2: -n1	1 - 4		1	4
81	516-549	516-557	—	K: -n6	—	.1001 - .1009		9	
	516-901	516-301	—	00: -n6	—	.101 - .149		.001	49
	516-902	516-302	—	0: -n6	0: -n1	.05 - .95		.05	19
	516-903	516-303	—	1: -n6	1: -n1	1 - 4		1	4
	516-904	516-304	—	2: -n6	2: -n1				
49	—	—	—	—	—	.1001 - .1009		9	
	—	—	—	—	—	.101 - .109		.001	9
	516-910	—	—	—	0: -n1	.01 - .19		.01	19
	516-911	—	—	—	1: -n1	.2 - .9		.1	8
516-912	—	—	—	2: -n1	1 - 4	1	4		
35	516-550	516-558	—	K: -n6	—	.10005		1	
	516-913	516-313	—	00: -n6	—	.1001 - .1009		.0001	9
	516-914	516-314	—	0: -n6	0: -n1	.101 - .109		.001	9
	516-915	516-315	—	1: -n6	1: -n1	.11 - .19		.01	9
	516-916	516-316	—	2: -n6	2: -n1	.1 - .3		.1	3
	516-916	516-316	—	2: -n6	2: -n1	.5, 1, 2, 4			4

Thin Block Sets									
Blocks per set	Order No.		Standard / grade available and Suffix No.*			Blocks included in set			
	Steel	CERA	ISO/DIN/JIS	ASME	BS	Size	Step	Qty.	
28	516-551	—	—	K: -n6	—	.02005		1	
	516-917	—	—	00: -n6	—	.0201 - .0209		.0001	9
	516-918	—	—	0: -n6	—	.021 - .029		.001	9
	516-919	—	—	1: -n6	—	.01 - .09		.01	9
	516-920	—	—	2: -n6	—				
10	516-926	—	—	0: -n6	0: -n1	.005 - .050		10	
	516-927	—	—	1: -n6	1: -n1				
	516-928	—	—	—	2: -n1				

Long Block Sets									
Blocks per set	Order No.		Standard / grade available and Suffix No.*			Blocks included in set			
	Steel	CERA	ISO/DIN/JIS	ASME	BS	Size	Step	Qty.	
8	—	516-564	—	K: -n6	—	5 - 7		3	
	—	516-741	—	00: -n6	—	8, 10, 12		2	3
	516-712	516-742	—	0: -n6	—	16, 20		4	2
	516-713	516-743	—	1: -n6	—				

Wear Block Sets								
Blocks per set	Order No.		Standard / grade available and Suffix No.*			Blocks included in set		
	Carbide	CERA	ISO/DIN/JIS	ASME	BS	Size	Step	Qty.
2	516-809	516-836	—	0: -n6	—	.05		2
	516-808	516-837	—	1: -n6	—			
2	516-805	516-834	—	0: -n6	—	.1		2
	516-804	516-835	—	1: -n6	—			

Micrometer Inspection Gauge Block Sets

- Dedicated gauge block sets for micrometer inspection.
 Sets **516-106/7/8** and **516-322/3** are recommended for checking instrumental errors in micrometers due to the choice of block sizes ensuring that the instrument is checked through a full rotation of the spindle over the range 0-25mm (or 0-1").
 Sets **516-115/6/7**, **516-165/6** and **516-177** contain blocks in 25mm (or 1") steps for aiding inspection of large micrometers in conjunction with one of the abovementioned sets.
 Sets **516-580/1/2**, **516-390/1/2** are dedicated to the QuantuMike with its 2mm/rev spindle feed.

Steel

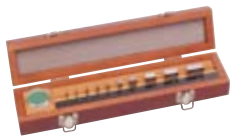

Steel 10-block set



Steel 10-block set



Steel 8-block set



Steel 10-block set

CERA



CERA 10-block set



CERA 10-block set



CERA 8-block set



CERA 10-block set

Micro Checker

Can clamp a stack of gauge blocks to be used for micrometer inspection.



516-607

(The gauge blocks are optional.)

SPECIFICATIONS

Metric		Micro Checker (holder only)
Order No.	516-607	
Applicable gauge block set	516-106, 516-107, 516-108, 516-156, 516-157, 516-158	
Applicable gauge block size (mm)	2.5, 5.1, 7.7, 10.3, 12.9, 15, 17.6, 20.2, 22.8, 25	

Inch		Micro Checker (holder only)
Order No.	516-608	
Applicable gauge block set	516-921, 516-922, 516-923, 516-321, 516-322, 516-323	
Applicable gauge block size (inch)	.105, .210, .315, .420, .5, .605, .710, .815, .920, 1	

Gauge Block Sets for Micrometer Inspection

A set consisting of a Micro Checker and gauge blocks for micrometer inspection. (**516-132/3/4/5/6/7**)



SPECIFICATIONS

Metric Block Sets						
Blocks per set	Order No.		Standard / grade available and Suffix No.*			Blocks included in set
	Steel	CERA	ISO/DIN/JIS	ASME	BS	
16	516-111	516-161	0: -n0	—	—	1.00, 1.25, 1.5, 2, 3, 5, 10, 15, 20, 25, 25.25, 30, 35, 40, 45, 50mm, Cerastone, Optical parallels (t = 12mm, 25mm)
	516-112	516-162	1: -n0	—	—	
	516-113	516-163	2: -n0	—	—	
10	516-977	—	K: -n0	—	—	1.00, 1.25, 1.50, 2, 3, 5, 10, 15, 20, 25mm, Optical parallel (t = 12mm)
	516-978	516-378	0: -n0	—	—	
	516-979	516-379	1: -n0	—	—	
	516-980	516-380	2: -n0	—	—	
10	516-103	516-152	0: -n6	—	—	1.00, 1.25, 1.50, 2, 3, 5, 10, 15, 20, 25mm
	516-101	516-153	1: -n0	1: -n6	—	
	—	516-154	2: -n0	—	—	
10	516-580	516-390	0: -n0	—	—	2.2, 4.8, 7.8, 10.4, 12, 15.2, 17.4, 19.6, 22.6, 25mm
	516-581	516-391	1: -n0	—	—	
	516-582	516-392	2: -n0	—	—	
10	516-106	516-156	0: -n0	—	—	2.5, 5.1, 7.7, 10.3, 12.9, 15, 17.6, 20.2, 22.8, 25mm, Optical parallel (t = 12mm)
	516-107	516-157	1: -n0	—	—	
	516-108	516-158	2: -n0	—	—	
10	516-132	516-182	0: -n0	—	—	1.25, 1.50, 1, 2, 3, 5, 10, 15, 20, 25mm, Micro Checker, Optical parallel (t = 12mm)
	516-133	516-183	1: -n0	—	—	
	516-134	516-184	2: -n0	—	—	
10	516-135	516-185	0: -n0	—	—	2.5, 5.1, 7.7, 10.3, 12.9, 15, 17.6, 20.2, 22.8, 25mm, Micro Checker, Optical parallel (t = 12mm)
	516-136	516-186	1: -n0	—	—	
	516-137	516-187	2: -n0	—	—	
8	—	516-547	—	K: -n6	—	25, 50, 75, 100, 125, 150, 175, 200mm
	—	516-164	K: -n0	00: -n6	—	
	516-115	516-165	0: -n0	0: -n6	—	
	516-116	516-166	1: -n0	1: -n6	—	
	516-117	516-167	2: -n0	2: -n6	—	

Inch Block Sets						
Blocks per set	Order No.		Standard / grade available and Suffix No.*			Blocks included in set
	Steel	CERA	ISO/DIN/JIS	ASME	BS	
10	516-528	516-318	—	00: -n6	0: -n1	.087, .189, .307, .409, .472, .598, .669, .772, .890, 1"
	516-529	516-319	—	0: -n6	1: -n1	
	516-530	516-320	—	1: -n6	2: -n1	
10	516-552	516-559	—	K: -n6	—	.105, .210, .315, .420, .500, .605, .710, .815, .920, 1", Optical parallel (t = .5")
	516-921	516-321	—	00: -n6	0: -n1	
	516-922	516-322	—	0: -n6	1: -n1	
	516-923	516-323	—	1: -n6	2: -n1	
10	516-553	516-560	—	K: -n6	—	.105, .210, .315, .420, .500, .605, .710, .815, .920, 1", Micro checker, Optical parallel (t = .5")
	516-138	516-188	—	00: -n6	0: -n1	
	516-139	516-189	—	0: -n6	1: -n1	
	516-140	516-190	—	1: -n6	2: -n1	
9	516-554	516-561	—	K: -n6	—	.0625, .100, .125, .200, .250, .300, .500, 1, 2", Optical parallel (t = .5")
	516-929	516-333	—	00: -n6	—	
	516-930	516-334	—	0: -n6	—	
	516-931	516-335	—	1: -n6	—	
	516-932	516-336	—	2: -n6	—	
9	516-555	516-562	—	K: -n6	—	.0625, .100, .125, .200, .250, .300, .500, 1, 2", Micro Checker, Optical parallel (t = .5")
	516-141	516-191	—	00: -n6	—	
	516-142	516-192	—	0: -n6	—	
	516-143	516-193	—	1: -n6	—	
	516-144	516-194	—	2: -n6	—	
9	—	516-563	—	K: -n6	—	.0625, .100, .125, .200, .250, .300, .500, 1, 2"
	—	516-329	—	00: -n6	—	
	516-934	516-330	—	0: -n6	—	
	516-935	516-331	—	1: -n6	—	
	516-936	516-332	—	2: -n6	—	
8	516-126	516-176	—	0: -n6	—	1, 2, 3, 4, 5, 6, 7, 8"
	516-127	516-177	—	1: -n6	—	

Caliper Inspection Gauge Block Sets

SPECIFICATIONS

Metric Block Sets						
Blocks per set	Order No.		Standard / grade available and Suffix No.			Blocks included in set
	Steel	CERA	ISO/DIN/JIS	ASME	BS	
5	—	516-174	2: -10	—	—	5 pcs.: 10.3, 24.5, 50, 75, 100mm, Ceramic plain jaws, Holder (250mm), Glove
4	516-526	516-566	1: -10	—	—	4 pcs.: 10, 30, 50, 125mm, Setting ring (ø4mm, ø10mm), Pin gage (ø10mm), Glove
	516-527	516-567	2: -10	—	—	
3	516-124	516-150	1: -10	—	—	3 pcs.: 30, 41.3, 131.4mm, Setting ring (ø4mm, ø25mm), Glove
	516-125	516-151	2: -10	—	—	
2	516-122	516-172	1: -10	—	—	2 pcs.: 41.3, 131.4mm, Setting ring (ø20mm), Glove
	516-123	516-173	2: -10	—	—	

* Suffix Number (n) for Selecting Standard and Certificate Provided

ISO/DIN/JIS		
Suffix No.	Inspection Certificate	Calibration Certificate
1	○	—
6	○	○

Suffix No. 1: Not available for Grade K sets.

ASME		
Suffix No.	Inspection Certificate	Calibration Certificate
1	○	—
6	○	○

Suffix No. 1: Not available for Grade K sets.
Suffix No. 6: Only for Grade K sets.

BS		
Suffix No.	Inspection Certificate	Calibration Certificate
1	○	—

Inspection Certificate

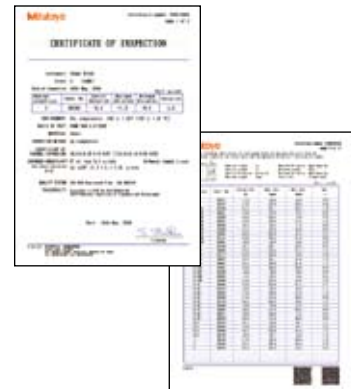

Tài liệu được tổng hợp bởi đội ngũ kỹ thuật của NPOWER
Bản quyền nội dung thuộc về Mitutoyo

Powered by NAVITECH | www.navitech.com
www.npower.com.vn

Individual Metric Rectangular Gauge Blocks

* Suffix Number (-nnn) for Selecting Standard and Certificate Provided

ISO/DIN/JIS				
Suffix No.	Grade	Inspection Certificate	Calibration Certificate	
			JCSS	RvA
-016	K	○	○	—
-021	0	○	—	—
-026	0	○	○	—
-031	1	○	—	—
-036	1	○	○	—
-041	2	○	—	—
-046	2	○	○	—

ASME			
Suffix No.	Grade	Inspection Certificate	Calibration Certificate
			JCSS
-516	K	○	○
-521	00	○	—
-531	0	○	—
-541	1	○	—
-551	2	○	—

BS			
Suffix No.	Grade	Inspection Certificate	Calibration Certificate
			JCSS
-116	K	○	○
-121	0	○	—
-126	0	○	○
-131	1	○	—
-136	1	○	○
-141	2	○	—
-146	2	○	○



Inspection Certificate

- If using only one length repeatedly, it is a good idea to purchase individual gauge blocks.
- Nominal sizes which are not included in the chart below can be supplied custom-made on request.
- Each Grade K gauge block to ISO/DIN/JIS, BS or ASME standard is supplied with a Certificate of Calibration which certifies that the gauge block was calibrated by interferometry.



SPECIFICATIONS

* Refer to "Classification of Gauge Blocks by Shape" on page 37 for sizes and forms, and "Accuracies of Mitutoyo Gauge Blocks" on page 8 and 9 for accuracy.

Metric Blocks								
Length (mm)	Order No.*		Length (mm)	Order No.*		Length (mm)	Order No.*	
	Steel	CERA		Steel	CERA		Steel	CERA
0.1	611821	—	0.53	611894	—	0.96	611937	—
0.11	611860	—	0.54	611895	—	0.97	611938	—
0.12	611861	—	0.55	611896	—	0.98	611939	—
0.13	611862	—	0.56	611897	—	0.99	611940	—
0.14	611863	—	0.57	611898	—	0.991	611551	613551
0.15	611822	—	0.58	611899	—	0.992	611552	613552
0.16	611864	—	0.59	611900	—	0.993	611553	613553
0.17	611865	—	0.6	611901	—	0.994	611554	613554
0.18	611866	—	0.61	611902	—	0.995	611555	613555
0.19	611867	—	0.62	611903	—	0.996	611556	613556
0.2	611823	—	0.63	611904	—	0.997	611557	613557
0.21	611868	—	0.64	611905	—	0.998	611558	613558
0.22	611869	—	0.65	611906	—	0.999	611559	613559
0.23	611870	—	0.66	611907	—	1	611611	613611
0.24	611871	—	0.67	611908	—	1.0005	611520	613520
0.25	611824	—	0.68	611909	—	1.001	611521	613521
0.26	611872	—	0.69	611910	—	1.002	611522	613522
0.27	611873	—	0.7	611911	—	1.003	611523	613523
0.28	611874	—	0.71	611912	—	1.004	611524	613524
0.29	611875	—	0.72	611913	—	1.005	611525	613525
0.3	611825	—	0.73	611914	—	1.006	611526	613526
0.31	611876	—	0.74	611915	—	1.007	611527	613527
0.32	611877	—	0.75	611916	—	1.008	611528	613528
0.33	611878	—	0.76	611917	—	1.009	611529	613529
0.34	611879	—	0.77	611918	—	1.01	611561	613561
0.35	611826	—	0.78	611919	—	1.02	611562	613562
0.36	611880	—	0.79	611920	—	1.03	611563	613563
0.37	611881	—	0.8	611921	—	1.04	611564	613564
0.38	611882	—	0.81	611922	—	1.05	611565	613565
0.39	611883	—	0.82	611923	—	1.06	611566	613566
0.4	611827	—	0.83	611924	—	1.07	611567	613567
0.41	611884	—	0.84	611925	—	1.08	611568	613568
0.42	611885	—	0.85	611926	—	1.09	611569	613569
0.43	611886	—	0.86	611927	—	1.1	611570	613570
0.44	611887	—	0.87	611928	—	1.11	611571	613571
0.45	611828	—	0.88	611929	—	1.12	611572	613572
0.46	611888	—	0.89	611930	—	1.13	611573	613573
0.47	611889	—	0.9	611931	—	1.14	611574	613574
0.48	611890	—	0.91	611932	—	1.15	611575	613575
0.49	611891	—	0.92	611933	—	1.16	611576	613576
0.5	611506	613506	0.93	611934	—	1.17	611577	613577
0.51	611892	—	0.94	611935	—	1.18	611578	613578
0.52	611893	—	0.95	611936	—	1.19	611579	613579



Tài liệu được tổng hợp bởi đội ngũ kỹ thuật của NPOWER
Bản quyền nội dung thuộc về Mitutoyo

Powered by NAVITECH | www.navitech.co
www.npower.com.vn

* Refer to "Classification of Gauge Blocks by Shape" on page 37 for sizes and forms, and "Accuracies of Mitutoyo Gauge Blocks" on page 8 and 9 for accuracy.

Length (mm)	Order No.*	
	Steel	CERA
1.2	611580	613580
1.21	611581	613581
1.22	611582	613582
1.23	611583	613583
1.24	611584	613584
1.25	611585	613585
1.26	611586	613586
1.27	611587	613587
1.28	611588	613588
1.29	611589	613589
1.3	611590	613590
1.31	611591	613591
1.32	611592	613592
1.33	611593	613593
1.34	611594	613594
1.35	611595	613595
1.36	611596	613596
1.37	611597	613597
1.38	611598	613598
1.39	611599	613599
1.4	611600	613600
1.41	611601	613601
1.42	611602	613602
1.43	611603	613603
1.44	611604	613604
1.45	611605	613605
1.46	611606	613606
1.47	611607	613607
1.48	611608	613608
1.49	611609	613609
1.5	611641	613641
1.6	611516	613516
1.7	611517	613517
1.8	611518	613518
1.9	611519	613519
2	611612	613612
2.0005	611690	—
2.001	611691	—
2.002	611692	—
2.003	611693	—
2.004	611694	—
2.005	611695	—
2.006	611696	—
2.007	611697	—
2.008	611698	—
2.009	611699	—
2.01	611701	—
2.02	611702	—
2.03	611703	—
2.04	611704	—
2.05	611705	—
2.06	611706	—
2.07	611707	—
2.08	611708	—
2.09	611709	—
2.1	611710	—
2.11	611711	—
2.12	611712	—
2.13	611713	—
2.14	611714	—
2.15	611715	—
2.16	611716	—

Length (mm)	Order No.*	
	Steel	CERA
2.17	611717	—
2.18	611718	—
2.19	611719	—
2.2	611720	—
2.21	611721	—
2.22	611722	—
2.23	611723	—
2.24	611724	—
2.25	611725	—
2.26	611726	—
2.27	611727	—
2.28	611728	—
2.29	611729	—
2.3	611730	—
2.31	611731	—
2.32	611732	—
2.33	611733	—
2.34	611734	—
2.35	611735	—
2.36	611736	—
2.37	611737	—
2.38	611738	—
2.39	611739	—
2.4	611740	—
2.41	611741	—
2.42	611742	—
2.43	611743	—
2.44	611744	—
2.45	611745	—
2.46	611746	—
2.47	611747	—
2.48	611748	—
2.49	611749	—
2.5	611642	613642
2.6	611750	—
2.7	611751	—
2.8	611752	—
2.9	611753	—
3	611613	613613
3.5	611643	613643
4	611614	613614
4.5	611644	613644
5	611615	613615
5.1	611850	613850
5.5	611645	613645
6	611616	613616
6.5	611646	613646
7	611617	613617
7.5	611647	613647
7.7	611851	613851
8	611618	613618
8.5	611648	613648
9	611619	613619
9.5	611649	613649
10	611671	613671
10.3	611852	613852
10.5	611650	613650
11	611621	613621
11.5	611651	613651
12	611622	613622
12.5	611652	613652
12.9	611853	613853

Length (mm)	Order No.*	
	Steel	CERA
13	611623	613623
13.5	611653	613653
14	611624	613624
14.5	611654	613654
15	611625	613625
15.5	611655	613655
16	611626	613626
16.5	611656	613656
17	611627	613627
17.5	611657	613657
17.6	611854	613854
18	611628	613628
18.5	611658	613658
19	611629	613629
19.5	611659	613659
20	611672	613672
20.2	611855	613855
20.5	611660	613660
21	611631	613631
21.5	611661	613661
22	611632	613632
22.5	611662	613662
22.8	611856	613856
23	611633	613633
23.5	611663	613663
24	611634	613634
24.5	611664	613664
25	611635	613635
25.25	611754	613754
30	611673	613673
35	611755	613755
40	611674	613674
41.3	611857	613857
45	611756	613756
50	611675	613675
60	611676	613676
70	611677	613677
75	611801	613801
80	611678	613678
90	611679	613679
100	611681	613681
125	611802	613802
131.4	611858	613858
150	611803	613803
175	611804	613804
200	611682	613682
250	611805	613805
300	611683	613683
400	611684	613684
500	611685	613685
600	611840	—
700	611841	—
750	611842	—
800	611843	—
900	611844	—
1000	611845	—

Metric Wear Blocks	
Length (mm)	Order No.* Tungsten carbide
1	612611
2	612612

Dimensions

Unit: mm

Nominal length:
0.1mm - 5.5mm
(.004" - .25")

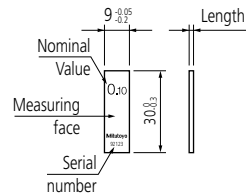

Nominal length:
6mm - 10mm
(.3" - .4")

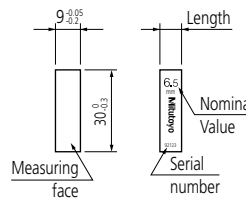

Nominal length:
10.3mm - 100mm
(.45" - 4")

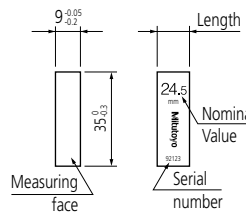

Nominal length 125mm - 1000mm (5" - 20")

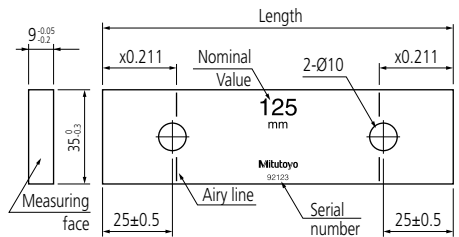

Individual Inch Rectangular Gauge Blocks

* Suffix Number (-nnn) for Selecting Standard and Certificate Provided

ASME			
Suffix No.	Grade	Inspection Certificate	Calibration Certificate JCSS
-516	K	○	○
-521	00	○	—
-531	0	○	—
-541	1	○	—
-551	2	○	—

BS			
Suffix No.	Grade	Inspection Certificate	Calibration Certificate JCSS
-121	0	○	—
-131	1	○	—
-141	2	○	—



Inspection Certificate

SPECIFICATIONS

* Refer to "Classification of Gauge Blocks by Shape" on page 37 for sizes and forms, and "Accuracies of Mitutoyo Gauge Blocks" on page 8 and 9 for accuracy.

Inch Blocks		
Length (inch)	Order No.*	
	Steel	CERA
.004	611304	—
.005	611305	—
.006	611306	—
.007	611307	—
.008	611308	—
.009	611309	—
.01	611310	—
.011	611311	—
.012	611312	—
.013	611313	—
.014	611314	—
.015	611315	—
.016	611316	—
.017	611317	—
.018	611318	—
.019	611319	—
.02	611320	—
.02005	611240	—
.0201	611231	—
.0202	611232	—
.0203	611233	—
.0204	611234	—
.0205	611235	—
.0206	611236	—
.0207	611237	—
.0208	611238	—
.0209	611239	—
.021	611321	—
.022	611322	—
.023	611323	—
.024	611324	—
.025	611325	—
.026	611326	—
.027	611327	—
.028	611328	—
.029	611329	—
.03	611330	—
.031	611331	—
.03125 (1/32)	611101	613103
.032	611332	—
.033	611333	—
.034	611334	—
.035	611335	—
.036	611336	—
.037	611337	—

Length (inch)	Order No.*	
	Steel	CERA
.038	611338	—
.039	611339	—
.04	611340	—
.041	611341	—
.042	611342	—
.043	611343	—
.044	611344	—
.045	611345	—
.046	611346	—
.046875 (3/64)	611102	613104
.047	611347	—
.048	611348	—
.049	611349	—
.05	611105	613105
.06	611106	—
.0625	611303	613303
.07	611107	—
.078125 (5/64)	611103	613100
.08	611108	—
.09	611109	—
.09375 (3/32)	611104	613101
.1	611191	613191
.100025	611111	613110
.10005	611135	613135
.100075	611112	613111
.1001	611121	613121
.1002	611122	613122
.1003	611123	613123
.1004	611124	613124
.1005	611125	613125
.1006	611126	613126
.1007	611127	613127
.1008	611128	613128
.1009	611129	613129
.101	611141	613141
.102	611142	613142
.103	611143	613143
.104	611144	613144
.105	611145	613145
.106	611146	613146
.107	611147	613147
.108	611148	613148
.109	611149	613149
.109375 (7/64)	611110	613102



Tài liệu được tổng hợp bởi đội ngũ kỹ thuật của **NPOWER**
Bản quyền nội dung thuộc về **Mitutoyo**

Powered by **NAVITECH** | www.navitech.co
www.npower.com.vn

SPECIFICATIONS

* Refer to "Classification of Gauge Blocks by Shape" on page 37 for sizes and forms, and "Accuracies of Mitutoyo Gauge Blocks" on page 8 and 9 for accuracy.

Inch Blocks		
Length (inch)	Order No.*	
	Steel	CERA
.11	611150	613150
.111	611151	613151
.112	611152	613152
.113	611153	613153
.114	611154	613154
.115	611155	613155
.116	611156	613156
.117	611157	613157
.118	611158	613158
.119	611159	613159
.12	611160	613160
.121	611161	613161
.122	611162	613162
.123	611163	613163
.124	611164	613164
.125	611165	613165
.126	611166	613166
.127	611167	613167
.128	611168	613168
.129	611169	613169
.13	611170	613170
.131	611171	613171
.132	611172	613172
.133	611173	613173
.134	611174	613174
.135	611175	613175
.136	611176	613176
.137	611177	613177
.138	611178	613178
.139	611179	613179
.14	611180	613180
.141	611181	613181
.142	611182	613182
.143	611183	613183
.144	611184	613184
.145	611185	613185
.146	611186	613186
.147	611187	613187
.148	611188	613188
.149	611189	613189
.15	611115	613115
.16	611116	613116
.17	611117	613117
.18	611118	613118

Length (inch)	Order No.*	
	Steel	CERA
.19	611119	613119
.2	611192	613192
.21	611221	613221
.25	611212	613212
.3	611193	613193
.315	611209	613209
.35	611213	613213
.375 (3/8)	611113	613112
.4	611194	613194
.420	611210	613210
.45	611214	613214
.5	611195	613195
.55	611215	613215
.6	611196	613196
.605	611211	613211
.65	611216	613216
.7	611197	613197
.710	611220	613220
.75	611217	613217
.8	611198	613198
.815	611226	613226
.85	611218	613218
.9	611199	613199
.920	611227	613227
.95	611219	613219
1	611201	613201
2	611202	613202
3	611203	613203
4	611204	613204
5	611205	613205
6	611206	613206
7	611207	613207
8	611208	613208
10	611222	613222
12	611223	613223
16	611224	613224
20	611225	613225

Inch Wear Blocks	
Length (inch)	Order No.* Tungsten carbide
.05	612105
.1	612191

Dimensions

Unit: mm

Nominal length:
0.1mm - 5.5mm
(.004" - .25")

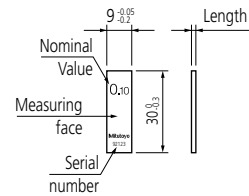

Nominal length:
6mm - 10mm
(.3" - .4")

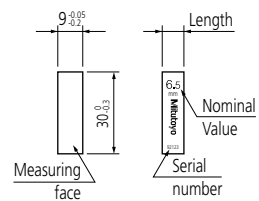

Nominal length:
10.3mm - 100mm
(.45" - 4")

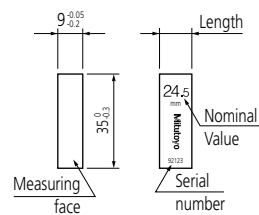

Nominal length 125mm - 1000mm (5" - 20")

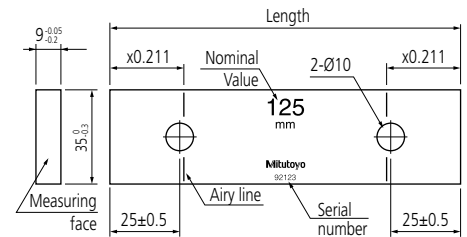

Rectangular Gauge Blocks Accessories

- To expand the range of rectangular gauge block (steel and CERA) applications, Mitutoyo offers the gauge block accessories set. By assembling the items in the set, together with gauge blocks, you can easily and quickly build up a precision gage.



516-601
(22 pcs)



516-602
(14 pcs)

SPECIFICATIONS

Item Description	Item Order No.	Set		Qty
		22 pcs 516-601	14 pcs 516-602	
Holder	619002	—	○	1 pc.
	619003	○	○	
	619004	○	○	
	619005	○	○	
Base	619009	○	○	
Half round jaw	619010	○	○	One pair (2pcs)
	619011	○	○	
	619012	○	○	
	619013	○	—	
	619014	○	—	
Plain jaw	619018	○	—	
Scriber point	619019	○	○	1 pc.
Center point	619020	○	○	
Tram point	619021	○	—	One pair (2pcs)
Triangular straight edge	619022	○	○	1 pc.
	619023	○	—	

* Only 1 pc is supplied for each Order No. However, half round jaw, plain jaw, and tram point are supplied in a pair. (2 pcs).

Holder

Thickness = 15mm
Width = 29.5mm

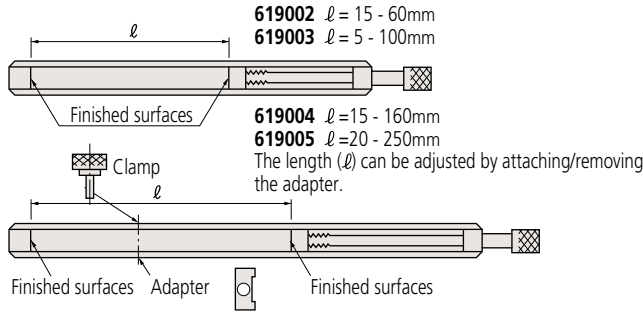

Gaging a bore using a pair of half round jaws and a holder



Marking a workpiece using the base, a holder and the scriber point



Setting a bore gage using a holder with the pair of Type I half-round jaws arranged as flat contact surfaces

Base 619009

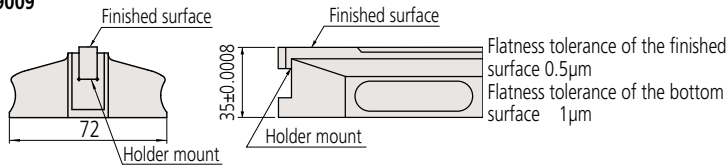

Half round jaw

Type I

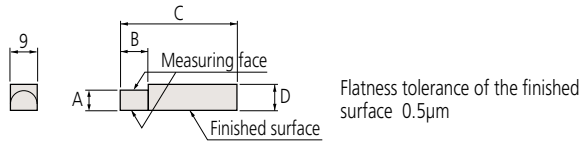

Type II

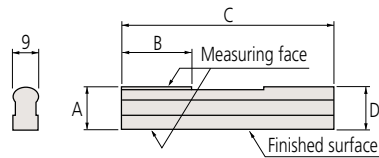

Unit: mm

Order No.	Type	Size	A	B	C	D
619010*1	I	2	2±0.0005	5.5	40	7.5
619011*1		5	5±0.0005	14	45	7.5
619012*1		8	8±0.0005	20	50	8.5
619013*1	II	12	12±0.0005	25	75	13
619014*1		20	20±0.0005	25	125	20

Plain jaw (B type) 619018*1

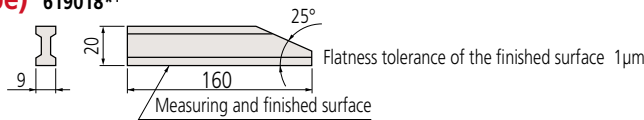

Scriber point

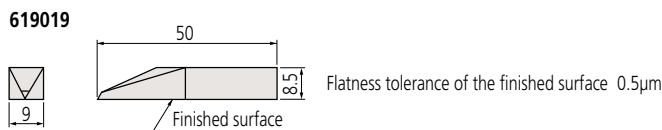

Center point

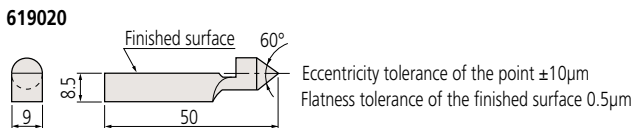

Tram point

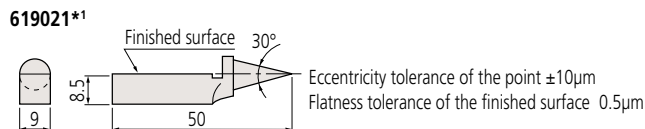

Triangular straight edge

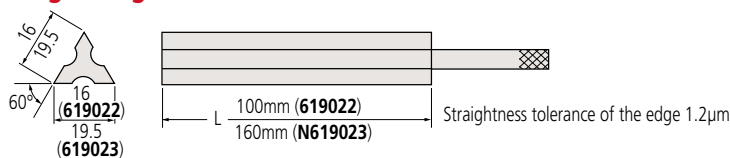

*1 Qty: One pair (2 pcs)

NPOWER
Powered by
Navitech

Tài liệu được tổng hợp bởi đội ngũ kỹ thuật của **NPOWER**
Bản quyền nội dung thuộc về **Mitutoyo**

Powered by **NAVITECH** | www.navitech.co
www.npower.com.vn

Accessories for Rectangular Gauge Blocks over 100mm

- Specially designed for long gauge blocks over 125mm which have two coupling holes on the body: coupling of two long gauge blocks and attachment of jaws is possible.
- These accessories can also be used for CERA blocks.



516-605
(14 pcs)

SPECIFICATIONS

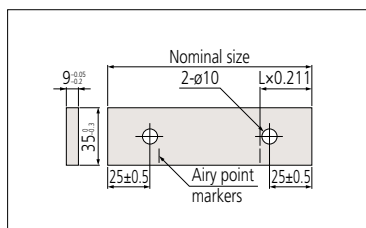

Coupling holes in long gauge blocks

Set Order No.	Individual Item Order No.	Item Description	Quantity Supplied
516-605	619031	Connector A	1 pc.
	619032	Connector B	
	619033	Connector C	
	619034	Connector D	
	619035	Connector E	
	619036	Adapter	3 pcs.
	619009	Base	1 pc.
	619013	Half round jaw	One pair (2pcs)
	619018	Plain jaw	
	619019	Scriber point	1 pc.

* Only 1 pc is supplied for each Order No. However, half round jaw, plain jaw, and tram point are supplied in a pair. (2 pcs).



Connector A 619031

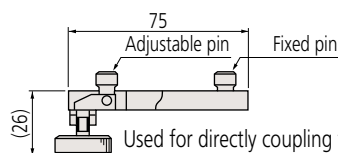

Used for directly coupling two long gauge blocks.



Use of B-type connectors in gage construction

Connectors B and C

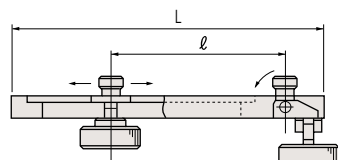

Adapter 619036

Used for clamping jaws to the ends of one or more long gauge blocks in conjunction with adapters (619036). The length l is highly adjustable to accommodate the variable length of a stack of regular gauge blocks that would be wrung to one of the long gauge blocks to achieve the required gaging size.

	Order No.	l (max.)	L	Adapter Qty
Connector B	619032	90mm	126mm	2
Connector C	619033	200mm	236mm	

Long and Ultra-Thin Gauge Blocks

Mitutoyo offers extra-thin gauge blocks from 0.10mm to 0.99mm (increments of 0.01mm) as well as long gauge blocks up to 1,000mm as standard products.

Connector D

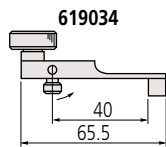

Used for attaching a long gauge block directly to the base.

Connector E

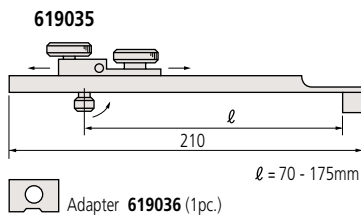

Used for attaching a long gauge block to the base over a stack of regular gauge blocks wrung between the base and long gauge block. The length ℓ is highly adjustable to accommodate the variable length of the stack.



Setting a dial test indicator to a long-gauge-block stack attached to the base with a D-type connector

Base

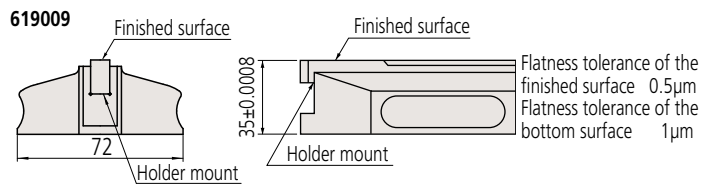

Plain jaw

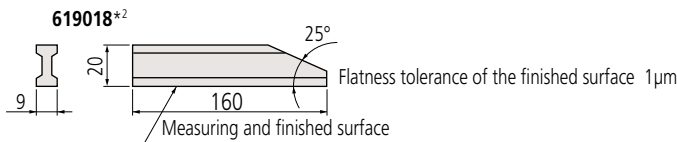

Half round jaw

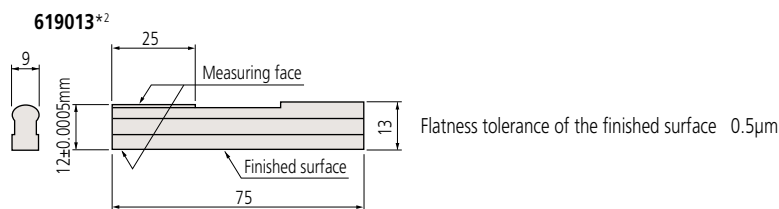

Scriber point

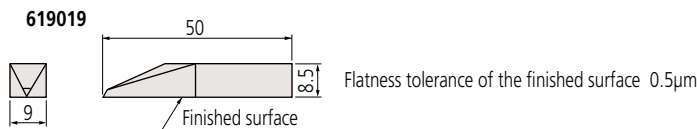

Assortment of accessories for gauge blocks

For inside and outside measurement inspection of 300 to 1000mm (every 100mm) gauge blocks, select the appropriate combination of a rectangular gauge block and an accessory.

Items	Order No.	300mm		400mm		500mm		600mm		700mm		800mm		900mm		1000mm	
		Inner	Outer	Inner	Outer	Inner	Outer	Inner	Outer	Inner	Outer	Inner	Outer	Inner	Outer	Inner	Outer
Rectangular gauge block (nominal dimension)	200mm	611682						1	1								
	300mm	611683	1	1						1	1	1	1				
	400mm	611684			1	1			1	1	1	1		1	1		
	500mm	611685					1	1					1	1	1	1	2
Connector A	619031							1	1	1	1	1	1	1	1	1	1
Connector B*1	619032	2		2		2		2		2		2		2		2	
Half round jaws*2	619013	1		1		1		1		1		1		1		1	
Adapter	619036	(2)		(2)		(2)		(2)		(2)		(2)		(2)		(2)	

*1 Provided with adapters (2 pcs)

*2 2 pcs/set

Metric/Inch Square Gauge Block Sets

Metric Block Sets, Inch Block Sets, Long Block Sets, Wear Block Sets

- Square gauge block sets have several unique characteristics (refer to page 10 for details.)
A wide choice is provided to best match the target applications: sets containing from 2 to 112 blocks are available.



Steel 112-block set



Steel 103-block set



Steel 76-block set



Steel 47-block set



Steel 32-block set

Wear block set



Tungsten Carbide 2-block set

Long block set



Steel 8-block set

The wear to a frequently used square gauge block set can be drastically reduced by using tungsten-carbide wear blocks on the ends of a stack. There are two available, of nominal dimension 1mm and 2mm. These blocks are much more wear-resistant than steel blocks, and they also absorb most of the wear that would otherwise occur to the blocks in the set due to contact, and therefore maximize the set's longevity. Wear blocks are relatively inexpensive so can be readily discarded when no longer serviceable. To achieve maximum protection, the same face of each wear block should always be wrung to a set block, so the opposite, wearing, face never touches a set block.

SPECIFICATIONS

Metric Block Sets							
Blocks per set	Order No.		Standard / grade available		Blocks included in set		
	Steel	CERA	ISO/DIN/JIS	ASME	Size	Step	Qty.
112	516-437	—	—	00: -n6	1.005	—	1
	516-438	—	0: -n0	0: -n6	1.001 - 1.009	0.001	9
	516-439	—	1: -n0	1: -n6	1.01 - 1.49	0.01	49
	516-440	—	2: -n0	2: -n6	0.5 - 24.5	0.5	49
103	516-441	—	—	00: -n6	1.005	—	1
	516-442	—	0: -n0	0: -n6	1.01 - 1.49	0.01	49
	516-443	—	1: -n0	1: -n6	0.5 - 24.5	0.5	49
	516-444	—	2: -n0	2: -n6	25 - 100	25	4
76	516-449	—	—	00: -n6	1.005	—	1
	516-450	—	0: -n0	0: -n6	1.01 - 1.49	0.01	49
	516-451	—	1: -n0	1: -n6	0.5 - 9.5	0.5	19
	516-452	—	2: -n0	2: -n6	10 - 40	10	4
47	516-457	—	—	00: -n6	1.005	—	1
	516-458	—	0: -n0	0: -n6	1.01 - 1.09	0.01	9
	516-459	—	1: -n0	1: -n6	1.1 - 1.9	0.1	9
	516-460	—	2: -n0	2: -n6	1 - 24	1	24
32	516-465	—	—	00: -n6	1.005	—	1
	516-466	—	0: -n0	0: -n6	1.01 - 1.09	0.01	9
	516-467	—	1: -n0	1: -n6	1.1 - 1.9	0.1	9
	516-468	—	2: -n0	2: -n6	1 - 9	1	9
					10 - 30	10	3
					60	60	1

Metric Long Block Sets							
Blocks per set	Order No.		Standard / grade available		Blocks included in set		
	Steel	CERA	ISO/DIN/JIS	ASME	Size	Step	Qty.
8	516-751	—	—	00: -n6	125, 150, 175	25	3
	516-752	—	0: -n0	0: -n6	200, 250	50	2
	516-753	—	1: -n0	1: -n6	300, 400, 500	100	3
	516-754	—	2: -n0	2: -n6			

Metric Wear Block Sets							
Blocks per set	Order No.		Standard / grade available		Blocks included in set		
	Steel	CERA	ISO/DIN/JIS	ASME	Size	Step	Qty.
2	516-820	—	0: -n0	—	1	—	2
	516-821	—	1: -n0	—			
2	516-822	—	0: -n0	—	2	—	2
	516-823	—	1: -n0	—			

Inch Block Sets							
Blocks per set	Order No.		Standard / grade available		Blocks included in set		
	Steel	CERA	ISO/DIN/JIS	ASME	Size	Step	Qty.
81	516-401	516-201	—	00: -n6	.1001 - .1009	.0001	9
	516-402	516-202	—	0: -n6	.101 - .149	.001	49
	516-403	516-203	—	1: -n6	.05 - .95	.05	19
	516-404	516-204	—	2: -n6	1 - 4	1	4
36	516-421	516-221	—	00: -n6	.05"	—	1
	516-422	516-222	—	0: -n6	.1001 - .1009	.0001	9
	516-423	516-223	—	1: -n6	.101 - .109	.001	9
	516-424	516-224	—	2: -n6	.11 - .19	.01	9
					.1 - .5	.1	5
					1, 2, 4	1	3
28	516-417	—	—	00: -n6	.02005	—	1
	516-418	—	—	0: -n6	.0201-.0209	.0001	9
	516-419	—	—	1: -n6	.021-.029	.001	9
	516-420	—	—	2: -n6	.010-.090	.01	9

Inch Long Block Sets							
Blocks per set	Order No.		Standard / grade available		Blocks included in set		
	Steel	CERA	ISO/DIN/JIS	ASME	Size	Step	Qty.
8	516-762	—	—	0: -n0	5 - 7	1	3
	516-763	—	—	1: -n0	8, 10, 12	2	3
					16, 20	4	2

Inch Wear Block Sets							
Blocks per set	Order No.		Standard / grade available		Blocks included in set		
	Carbide	CERA	ISO/DIN/JIS	ASME	Size	Step	Qty.
2	516-824	516-846	—	0: -n0	.05	—	2
	516-825	516-847	—	1: -n0			
2	516-826	516-844	—	0: -n0	.1	—	2
	516-827	516-845	—	1: -n0			

* Suffix Number (n) for Selecting Standard and Certificate Provided

ISO/DIN/JIS		
Suffix No.	Inspection Certificate	Calibration Certificate
		JCSS
1	○	—
6	○	○

ASME		
Suffix No.	Inspection Certificate	Calibration Certificate
		JCSS
1	○	—

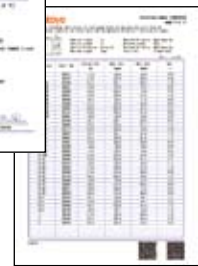

Inspection Certificate



Tài liệu được tổng hợp bởi đội ngũ kỹ thuật của **NPOWER**
Bản quyền nội dung thuộc về **Mitutoyo**

Powered by **NAVITECH** | www.navitech.co
www.npower.com.vn

Individual Metric Square Gauge Blocks

* Suffix Number (-nnn) for Selecting Standard and Certificate Provided

ISO/DIN/JIS			
Suffix No.	Grade	Inspection Certificate	Calibration Certificate
			JCSS
-021	0	○	—
-026	0	○	○
-031	1	○	—
-036	1	○	○
-041	2	○	—
-046	2	○	○

ASME			
Suffix No.	Grade	Inspection Certificate	Calibration Certificate
			JCSS
-521	00	○	—
-531	0	○	—
-541	1	○	—
-551	2	○	—



Inspection Certificate

- Purchase of individual metric square gauge blocks is economic if only specific sizes are heavily used.
- Please add the suffix number representing the national standard and grade required at the end of the Order No. when ordering these items.
- Special sizes that are not included in the charts can be supplied custom-made on request.



SPECIFICATIONS

* Refer to "Classification of Gauge Blocks by Shape" on page 37 for sizes and forms, and "Accuracies of Mitutoyo Gauge Blocks" on page 8 and 9 for accuracy.

Length (mm)	Order No.*	
	Steel	CERA
0.5	614506	—
1	614611	—
1.0005	614520	—
1.001	614521	—
1.002	614522	—
1.003	614523	—
1.004	614524	—
1.005	614525	—
1.006	614526	—
1.007	614527	—
1.008	614528	—
1.009	614529	—
1.01	614561	—
1.02	614562	—
1.03	614563	—
1.04	614564	—
1.05	614565	—
1.06	614566	—
1.07	614567	—
1.08	614568	—
1.09	614569	—
1.1	614570	—
1.11	614571	—
1.12	614572	—
1.13	614573	—
1.14	614574	—
1.15	614575	—
1.16	614576	—
1.17	614577	—
1.18	614578	—
1.19	614579	—
1.2	614580	—
1.21	614581	—
1.22	614582	—

Length (mm)	Order No.*	
	Steel	CERA
1.23	614583	—
1.24	614584	—
1.25	614585	—
1.26	614586	—
1.27	614587	—
1.28	614588	—
1.29	614589	—
1.3	614590	—
1.31	614591	—
1.32	614592	—
1.33	614593	—
1.34	614594	—
1.35	614595	—
1.36	614596	—
1.37	614597	—
1.38	614598	—
1.39	614599	—
1.4	614600	—
1.41	614601	—
1.42	614602	—
1.43	614603	—
1.44	614604	—
1.45	614605	—
1.46	614606	—
1.47	614607	—
1.48	614608	—
1.49	614609	—
1.5	614641	—
1.6	614516	—
1.7	614517	—
1.8	614518	—
1.9	614519	—
2	614612	—
2.5	614642	—

Length (mm)	Order No.*	
	Steel	CERA
3	614613	—
3.5	614643	—
4	614614	—
4.5	614644	—
5	614615	—
5.5	614645	—
6	614616	—
6.5	614646	—
7	614617	—
7.5	614647	—
8	614618	—
8.5	614648	—
9	614619	—
9.5	614649	—
10	614671	—
10.5	614650	—
11	614621	—
11.5	614651	—
12	614622	—
12.5	614652	—
13	614623	—
13.5	614653	—
14	614624	—
14.5	614654	—
15	614625	—
15.5	614655	—
16	614626	—
16.5	614656	—
17	614627	—
17.5	614657	—
18	614628	—
18.5	614658	—
19	614629	—
19.5	614659	—

Length (mm)	Order No.*	
	Steel	CERA
20	614672	—
20.5	614660	—
21	614631	—
21.5	614661	—
22	614632	—
22.5	614662	—
23	614633	—
23.5	614663	—
24	614634	—
24.5	614664	—
25	614635	—
30	614673	—
40	614674	—
50	614675	—
60	614676	—
75	614801	—
100	614681	—
125	614802	—
150	614803	—
175	614804	—
200	614682	—
250	614805	—
300	614683	—
400	614684	—
500	614685	—

Metric Wear Blocks	
Length (mm)	Order No. Tungsten carbide
1	615611
2	615612

Individual Inch Square Gauge Blocks

SPECIFICATIONS

* Refer to "Classification of Gauge Blocks by Shape" on page 37 for sizes and forms, and "Accuracies of Mitutoyo Gauge Blocks" on page 8 and 9 for accuracy.

Inch Blocks		
Length (inch)	Order No.*	
	Steel	CERA
.01	614310	—
.02005	614240	—
.0201	614231	—
.0202	614232	—
.0203	614233	—
.0204	614234	—
.0205	614235	—
.0206	614236	—
.0207	614237	—
.0208	614238	—
.0209	614239	—
.02	614320	—
.021	614321	—
.022	614322	—
.023	614323	—
.024	614324	—
.025	614325	—
.026	614326	—
.027	614327	—
.028	614328	—
.029	614329	—
.03	614330	—
.03125 (1/32)	614301	—
.04	614340	—
.046875 (3/64)	614302	—
.05	614105	616105
.06	614106	—
.0625	614303	616303
.07	614107	—
.078125 (5/64)	614304	—
.08	614108	—
.09	614109	—
.09375 (3/32)	614305	—
.1	614191	616191
.100025	614307	—
.10005	614135	616135
.100075	614308	—
.1001	614121	616121
.1002	614122	616122
.1003	614123	616123
.1004	614124	616124
.1005	614125	616125
.1006	614126	616126
.1007	614127	616127
.1008	614128	616128
.1009	614129	616129
.101	614141	616141
.102	614142	616142
.103	614143	616143
.104	614144	616144
.105	614145	616145
.106	614146	616146
.107	614147	616147
.108	614148	616148
.109	614149	616149
.109375 (7/64)	614306	—
.11	614150	616150
.111	614151	616151
.112	614152	616152
.113	614153	616153
.114	614154	616154
.115	614155	616155
.116	614156	616156
.117	614157	616157
.118	614158	616158
.119	614159	616159
.12	614160	616160
.121	614161	616161
.122	614162	616162

Length (inch)	Order No.*	
	Steel	CERA
.123	614163	616163
.124	614164	616164
.125	614165	616165
.126	614166	616166
.127	614167	616167
.128	614168	616168
.129	614169	616169
.13	614170	616170
.131	614171	616171
.132	614172	616172
.133	614173	616173
.134	614174	616174
.135	614175	616175
.136	614176	616176
.137	614177	616177
.138	614178	616178
.139	614179	616179
.14	614180	616180
.141	614181	616181
.142	614182	616182
.143	614183	616183
.144	614184	616184
.145	614185	616185
.146	614186	616186
.147	614187	616187
.148	614188	616188
.149	614189	616189
.15	614115	616115
.16	614116	616116
.17	614117	616117
.18	614118	616118
.19	614119	616119
.2	614192	616192
.25	614212	616212
.3	614193	616193
.35	614213	616213
.375 (3/8)	614309	—
.4	614194	616194
.45	614214	616214
.5	614195	616195
.55	614215	616215
.6	614196	616196
.65	614216	616216
.7	614197	616197
.75	614217	616217
.8	614198	616198
.85	614218	616218
.9	614199	616199
.95	614219	616219
1	614201	616201
2	614202	616202
3	614203	616203
4	614204	616204
5	614205	—
6	614206	—
7	614207	—
8	614208	—
10	614222	—
12	614223	—
16	614224	—
20	614225	—

Inch Wear Blocks	
Length (inch)	Order No.*
	Tungsten carbide
.05	615105
.1	615191

* Suffix Number (-nnn) for Selecting Standard and Certificate Provided

ASME			
Suffix No.	Grade	Inspection Certificate	Calibration Certificate
			JCSS
-521	00	○	—
-531	0	○	—
-541	1	○	—
-551	2	○	—



Inspection Certificate

Dimensions

Nominal length: 0.5mm - 4.5mm
(.010" - .19")

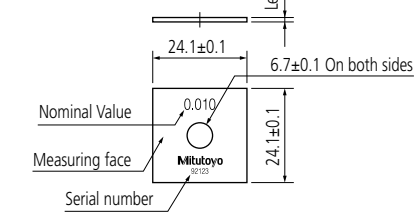

Nominal length: 5mm - 14.5mm
(.02" - .450")

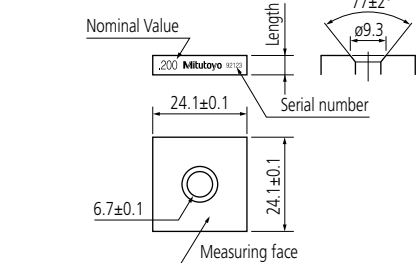

Nominal length: 15mm - 500mm
(.500" - 20")

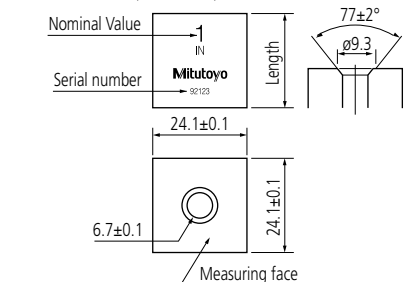

Square Gauge Block Accessories Set

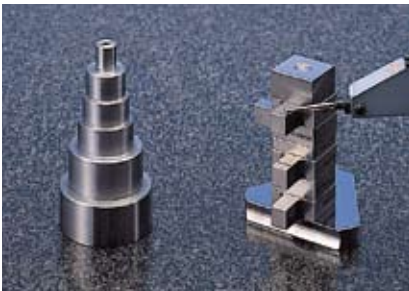

- To expand the application of square gauge blocks, Mitutoyo offers the Gauge Block Accessories Set. Square gauge blocks have a much broader range of application than rectangular gauge blocks due to the central clamping hole. Also, the accessories included in the set are sold individually depending on the application.



516-611

SPECIFICATIONS

Metric		
Order No. 516-611	Included in set	Quantity Supplied
619070	Half round jaw	2 pcs.
619071	Half round jaw	
619072	Plain jaw	1 pc.
619073	Center point	
619054	Scriber point	2 pcs.
619074	Base	
619057	Flat head screw	2 pcs.
619058	Flat head screw	
619059	Slotted head nut	1 pc.
619060	Adjustable tie rod	
619061	Adjustable tie rod	1 pc.
619062	Tie rod	
619063	Tie rod	1 pc.
619064	Tie rod	
619065	Tie rod	2 pcs.
619056	Stud	
619066	Knurled head screw	

Inch		
Order No. 516-612	Included in set	Quantity Supplied
619050	Half round jaw	2 pcs.
619051	Half round jaw	
619052	Plain jaw	1 pc.
619053	Center point	
619054	Scriber point	2 pcs.
619055	Base	
619057	Flat head screw	2 pcs.
619058	Flat head screw	
619059	Slotted head nut	1 pc.
619060	Adjustable tie rod	
619061	Adjustable tie rod	1 pc.
619062	Tie rod	
619063	Tie rod	1 pc.
619064	Tie rod	
619065	Tie rod	2 pcs.
619056	Stud	
619066	Knurled head screw	

* 2 pcs of half round jaw, plain jaw, stud, flat head screw, slotted head nut, adjustable tie rod, and knurled head screw are included in each set. Please note that the abovementioned Order No. indicates only 1 set.

Features of Square Gauge Blocks



1. Gauge blocks in a stack can be clamped together

After wringing square gauge blocks, a tie rod can be inserted through the center hole to clamp the blocks together for extra security.



2. A height reference standard can easily be made

A precision height reference standard can be made easily and inexpensively using accessories such as the plain jaw and block base.



3. A dedicated inspection jig can easily be made

A dedicated inspection jig for periodic inspection of instruments can be made easily and inexpensively.



4. A wide measuring surface with cross-sectional dimensions of 24.1 x 24.1mm is available.

A square gauge block retains stable orientation both longitudinally and laterally. A wide range of applications is covered, including cutting tool positioning, angle measurement with a sine bar, taper measurement with a roller, and inspection of depth micrometers.

Half round jaw

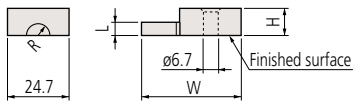

Order No.	R	L	W	H
619070	1.95mm	2mm	33.6mm	5.3mm
619071	4.95mm	5mm	39.9mm	10.3mm

- Flatness tolerance 0.5µm
- Parallelism tolerance of L 0.5µm
- Tolerance of L ±0.5µm

Plain jaw 619072

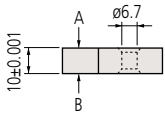
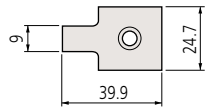

- Flatness tolerance 0.12µm
- Parallelism tolerance 0.12µm
- A and B are finished surfaces

Center point 619073

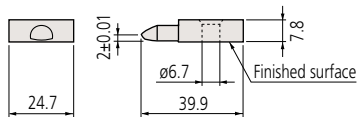

- Flatness tolerance 0.5µm

Scriber point 619054

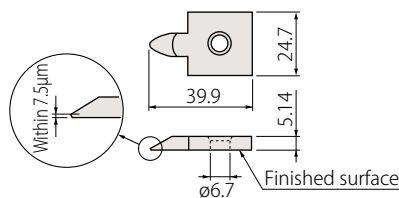

Base 619074

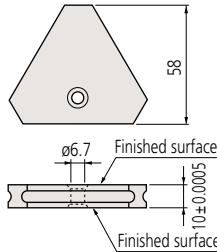

- Parallelism tolerance 1.5µm
- Flatness tolerance 1.5µm (The surface within 1.5mm of edge is excluded)

Flat head screw

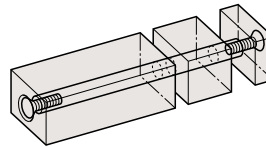
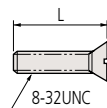

Order No.	L
619057	31.6mm
619058	15.8mm

Stud 619056

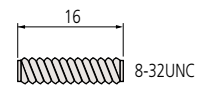

Slotted head nut 619059

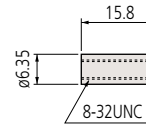

Knurled head screw 619066

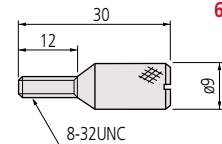

• Contraction caused by the clamping force

The minimum recommended torque to be applied to the clamping screws is approximately 600mN/m. The chart below shows the approximate length contraction of a 100mm gauge stack using typical torque values.

Driver	Contraction
Torque Driver 600mN-m	0.2µm/100mm
Ordinary Driver 700 - 800mN-m	0.3µm/100mm

Adjustable tie rod

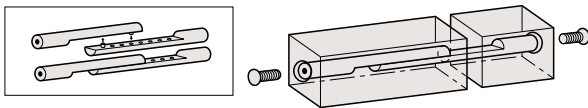
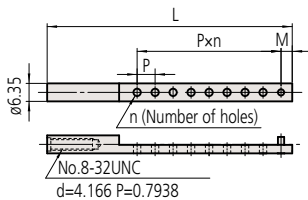

Order No.	L	M	P	n (Number of holes)
619060	124.5mm	3.85mm	6.35mm	14
619061	86.5mm	3.95mm	6.35mm	8

Tie rod

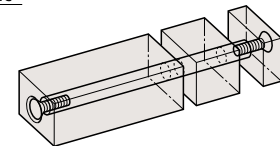
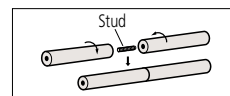
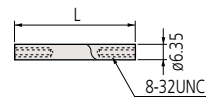

Order No.	L
619065	19mm
619064	38mm
619063	57mm
619062	76mm

Accessories used for combining square gauge blocks

Overall length (mm)		Min.	21	36	34	41	45	58	64	72	77	82	91	95	109	117	130	148	121	167	143	160	205	180	223	240	258	295	375		
Order No.	Included in set	Max.	30	43	43	50	60	72	79	88	91	97	107	109	125	135	150	169	180	184	210	255	270	285	288	345	363	445	520		
619059	Slotted head nut		1	1		1																									
619058	Flat head screw		1		2	1	2	1	2		1	2		1		1				2		2									
619057				1				1		2	1		2	1	2	1	2	2		2	2		2	2	2	2	2	2	2		
619056	Stud					1														1				1		1	1	1	1	2	
619065					1	1																									
619064								1	1		1																				
619063										1		1		1																	
619062													1		1	1	1	1	1												
619061	Adjustable tie rod																								2				2	2	
619060																									2	2	2	2	2	2	

Step Master

- Step Master is a gauge providing 4 small increments in height (steps) constructed from an assembly of 5 highly accurate steel or ceramic blocks.
- Each step is defined as the difference in height between the center of adjacent blocks, measured to a resolution of $0.01\mu\text{m}$ by using an interferometer with an accuracy tolerance of $\pm 0.20\mu\text{m}$.
- Steel and ceramic types are available to suit the application.
- Height differences are measured between the centers of adjacent steps.



Ceramic type
516-498

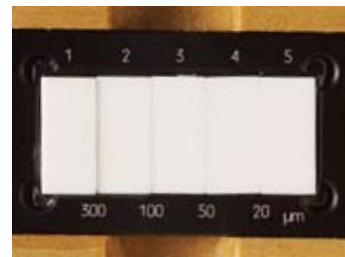

Ceramic type
516-499

SPECIFICATIONS

Steel type

Order No.	516-198					516-199				
Block No.	1	2	3	4	5	1	2	3	4	5
Cumulative step (μm)	0	10	15	17	18	0	300	400	450	470
Step value between adjacent blocks (μm)		10	5	2	1		300	100	50	20

Ceramic type

Order No.	516-498					516-499				
Block No.	1	2	3	4	5	1	2	3	4	5
Cumulative step (μm)	0	10	15	17	18	0	300	400	450	470
Step value between adjacent blocks (μm)		10	5	2	1		300	100	50	20

- ○ ○ - ○ ○ ○ - **64**: Provided with Calibration Certificate
- ○ ○ - ○ ○ ○ - **84**: Provided with Calibration Certificate and Traceability System Chart

DIMENSIONS

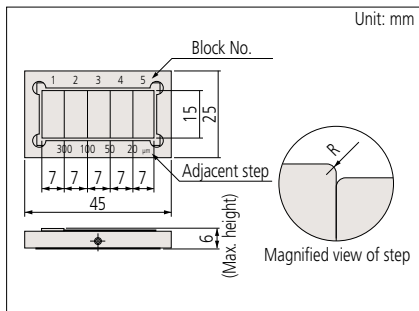

Custom-made Blocks & Gages

- Mitutoyo can manufacture Gauge Blocks and reference gages to your size and design.
- Nominal size range
 - 0.1mm to 1000mm (steel)
 - 0.5mm to 500mm (ceramic)
- Nominal size increment
 - 0.0005mm (up to 100mm)
 - 0.001mm (over 100mm)
- Cross section (same as the standard product)
 - Nominal length of 10mm or less: 30 x 9mm
 - Nominal length of more than 10mm: 35 x 9mm
 - Square types are also available.
- Special ultra-low expansion ceramic types are also available.
- Gauge Blocks and reference gages to your specifications (section dimensions) are available, including precision spacers which normally absorb much time and effort to manufacture in-house.
- Special processing including boring, step gaging and special marking are available. Consult us for details.

Typical examples of custom-made gauge blocks and reference gages.
Please enquire for price and delivery times for your particular requirements.

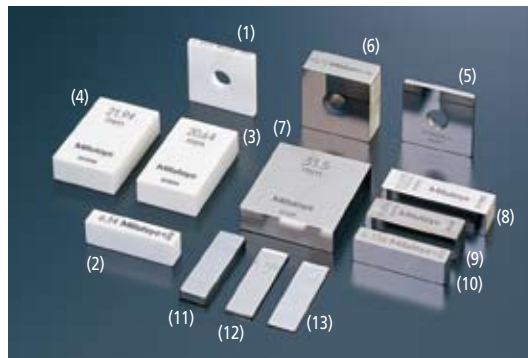

Ceramic

- (1) Square gauge block (2.1005mm)
- (2) Rectangular gauge block (6.34mm)
- (3) Rectangular gauge block (20.64mm)
- (4) Rectangular gauge block (21.94mm)

Steel

- (5) Square gauge block (2.2065mm)
- (6) Square gauge block (10.72mm)
- (7) Rectangular gauge block (31.5mm)
- (8) Rectangular gauge block (10.02mm)
- (9) Rectangular gauge block (9.694mm)
- (10) Rectangular gauge block (6.156mm)
- (11) Rectangular gauge block (3.603mm)
- (12) Rectangular gauge block (1.1505mm)
- (13) Rectangular gauge block (0.555mm)

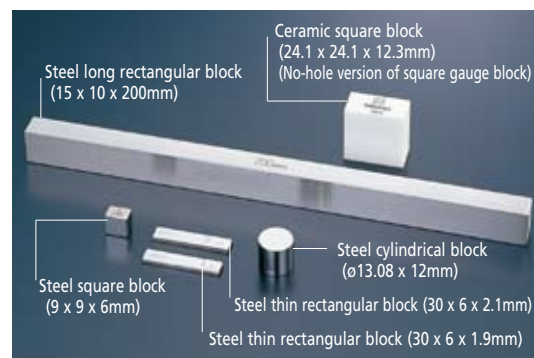
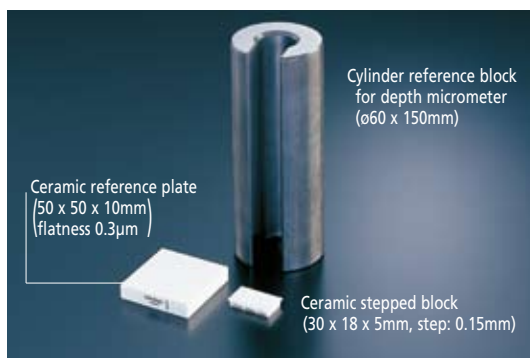

Maintenance Kit for Gauge Blocks



Recommendation for regular calibration

Gauge blocks are often used to define a company's standard of length for manufacturing and as such must be reliable. This means that they need regular calibration to verify accuracy. (The problem of damage or corrosion should be addressed during use and blocks seriously affected must be discarded immediately.) The frequency of calibration depends on the tolerance requirements of the work, the amount of use and conditions under which the gauge blocks are used. The most economical cycle for any particular set of gauge blocks is best determined by studying the calibration history. The list below indicates timings for a typical initial calibration cycle for the various grades of block.

Application	Cycle	Grade (reference)
Reference	1 - 2	K
Standard	2	K or 0
Inspection	2	0 or 1
Shop floor	0.5 - 1	1 or 2

As an accredited calibration laboratory, Mitutoyo offers a traceable calibration service for customers' gauge blocks. Our regular calibration service features:

- Gauge blocks manufactured by any maker can be calibrated.
- Cleansing and removal of burrs.
- Central dimension and dimensional deviations of each block are measured.
- Calibration results are provided for immediate use and for building a calibration history of each block.

- Maintenance kit for gauge blocks includes all the necessary maintenance tools for removing burrs and contamination, and applying anti-corrosion treatment after use, etc.



516-650

*Order No. 516-650E; 516-650

Tools and accessories included:

1. Anti-corrosion oil (**600001**) (100ml, spray can)
Used for both steel and tungsten-carbide gauge blocks.
2. Ceraston (**601645**) (both sides finished by lapping)
3. Optical flat (**158-117**) (ø45, 12mm thickness, JIS Grade 3)
Used to check the wringing of thin gauge blocks and for the presence of burrs.
4. Tweezers (**600004**)
Used for handling thin gauge blocks.
5. Blower brush (**600005**)
Used for blowing dust from measuring surfaces.
6. Cleaning paper (**600006**) (lens paper, 82 x 304mm, 500 pcs)
Used for wiping off rust preventive oil and contamination. Lint free.
7. Artificial leather mat (B4 size) (**600007**)
Used as a gauge block mat in order to avoid scratches on the work table
8. Reagent bottle (**600008**) (polyethylene container, 100ml)
Bottle of wiping solution. (Mitutoyo employs n-Heptane for solvent.)
9. Gloves (**600009**)
Used for handling large gauge blocks. Effective for the prevention of corrosion and thermal expansion.

* **516-650E**: Excluding anti-corrosive oil (**600001**)
516-650: including anti-corrosive oil (**600001**) is for domestic sales only.
 In the case of an order from overseas, place an order for **516-650E**: excluding anti-corrosive oil, and order anti-corrosive oil (**600001**) separately.



Tài liệu được tổng hợp bởi đội ngũ kỹ thuật của **NPOWER**
Bản quyền nội dung thuộc về **Mitutoyo**

Powered by **NAVITECH** | www.navitech.co
www.npower.com.vn

Ceraston

Accessory for Gauge Block Maintenance

- Alumina-ceramic abrasive stone for removing burrs from hard materials such as ceramics that ordinary stones cannot handle.
- Can be used both for steel gauge blocks and CERA blocks.
- Excellent in the ease of removing burrs and durability compared with Arkansas stones.
- Both sides can be used.

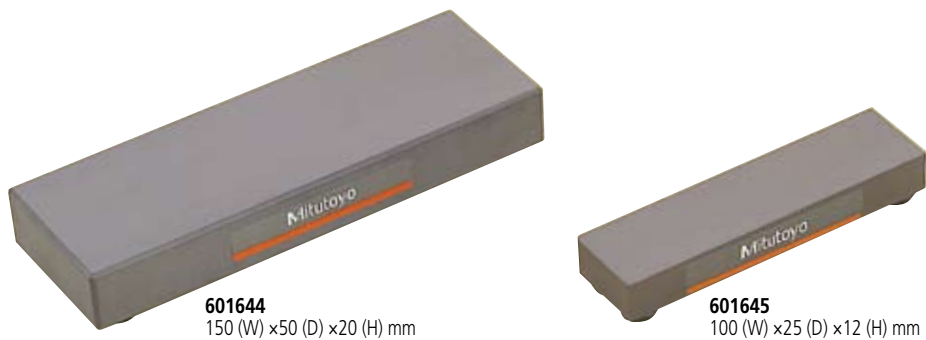

Application example

Removing burrs

Figure 1

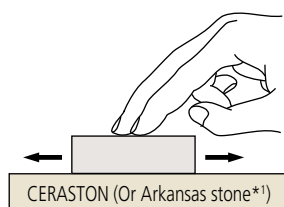
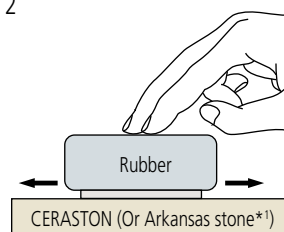

Figure 2



- (1) Wipe any dust and oil films from the gauge block and the Ceraston (or Arkansas stone) using a solvent.
- (2) Place the gauge block on the Ceraston so that the measuring face that has burrs is on the abrasive surface of the stone. While applying light pressure, move the gauge block to and fro about ten times (Fig. 1). Use a block rubber for thin gauge blocks to apply even pressure (Fig. 2).
- (3) Check the measuring face for burrs with an optical flat. If the burrs have not been removed, repeat step (2). If burrs are too large, they may not be removed with an abrasive stone. If so, discard the gauge block.

Note: The abrasive surface of a Ceraston must be made flat by lapping it from time to time. After lapping the Ceraston, the lapping powder must be completely removed from the surface to prevent the surface of the gauge block from being scratched.

*1 Mitutoyo does not offer Arkansas stones.

Quick Guide to Precision Measuring Instruments

Definition of the Meter

The 17th General Conference of Weights and Measures in 1983 decided on a new definition of the meter unit as the length of the path traveled by light in a vacuum during a time interval of $1/299\,792\,458$ of a second. The gauge block is the practical realization of this unit and as such is used widely throughout industry.

Selection, Preparation and Assembly of a Gauge Block Stack

Select gauge blocks to be combined to make up the size required for the stack.

- (1) Take the following things into account when selecting gauge blocks.
 - a. Use the minimum number of blocks whenever possible.
 - b. Select thick gauge blocks whenever possible.
 - c. Select the size from the one that has the least significant digit required, and then work back through the more significant digits.
- (2) Clean the gauge blocks with an appropriate cleaning agent.
- (3) Check the measuring faces for burrs by using an optical flat as follows:

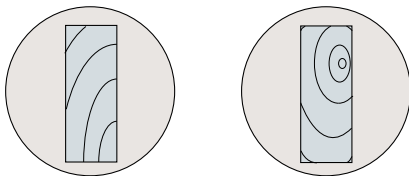

- a. Wipe each measuring face clean.
 - b. Gently place the optical flat on the gauge block measuring face.
 - c. Lightly slide the optical flat until interference fringes appear.

Judgment 1: If no interference fringes appear, it is assumed that there is a large burr or contaminant on the measuring face.
 - d. Lightly press the optical flat to check that the interference fringes disappear.

Judgment 2: If the interference fringes disappear, no burr exists on the measuring face.

Judgment 3: If some interference fringes remain locally while the flat is gently moved to and fro, a burr exists on the measuring face. If the fringes move along with the optical flat, there is a burr on the optical flat.
 - e. Remove burrs, if any, from the measuring face using a flat, fine-grained abrasive stone.
- (4) Apply a very small amount of oil to the measuring face and spread it evenly across the face. (Wipe the face until the oil film is almost removed.) Grease, spindle oil, vaseline, etc., are commonly used.

- (5) Gently overlay the faces of the gauge blocks to be wrung together.

There are three methods to use (a, b and c as shown below) according to the size of blocks being wrung:

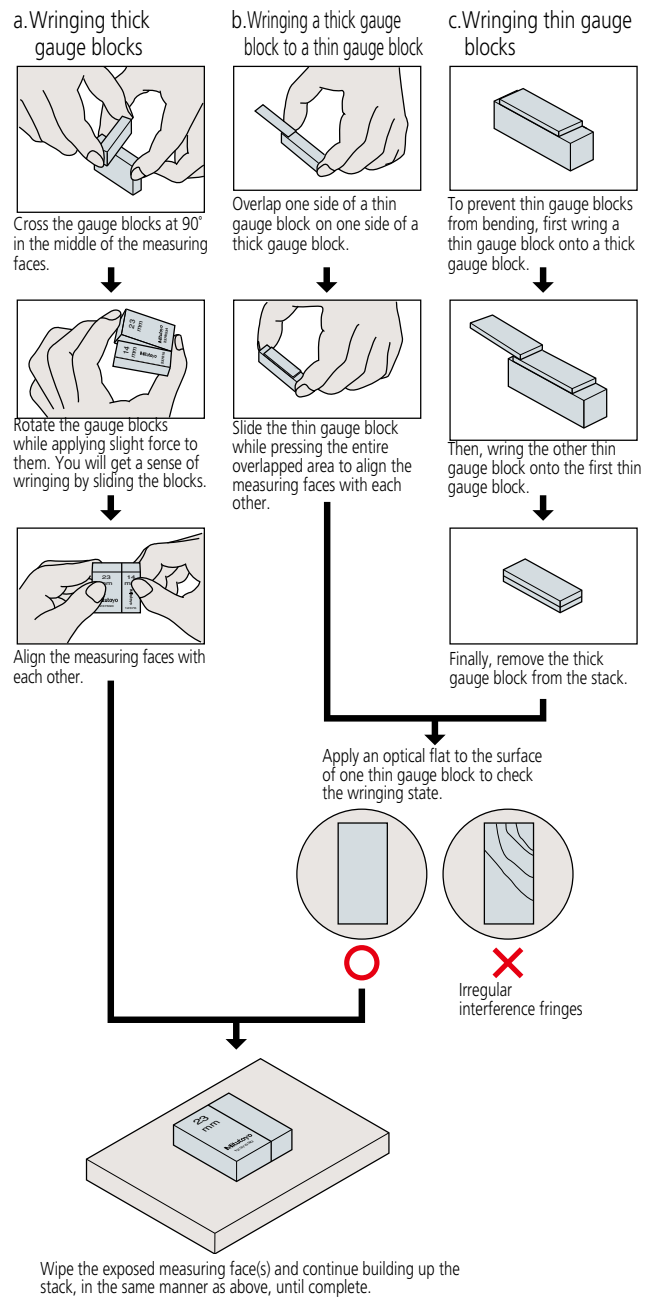

Thermal Stabilization Time

The following figure shows the degree of dimensional change when handling a 100mm steel gauge block with bare hands.

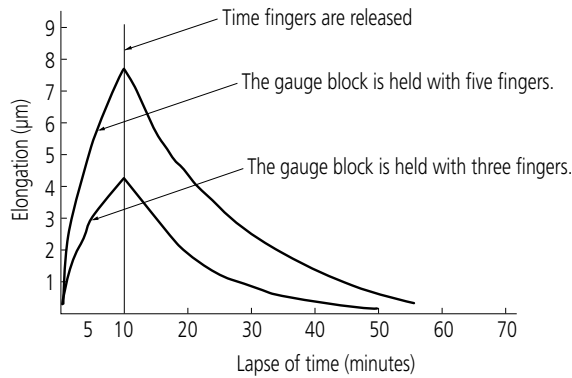

Classification of Gauge Blocks by Shape

Mitutoyo broadly divides gauge blocks into two categories according to the block shape.

Rectangular gauge blocks

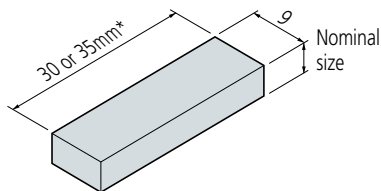

* Depends on the nominal size.
More than 10mm
10mm or less

Specially designed for long gauge blocks over 125mm which have two coupling holes on the body.

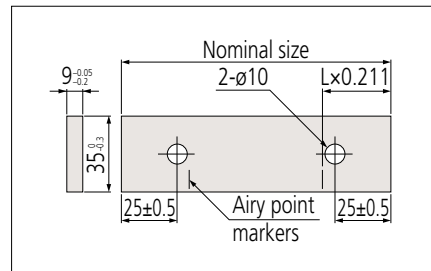

Coupling holes in long gauge blocks

Square gauge blocks

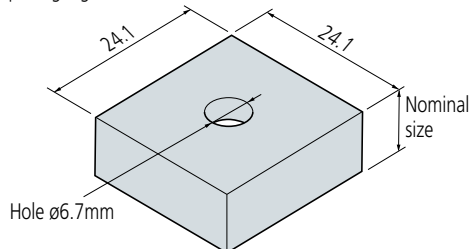

NPOWER
Powered by
NaviTech

Tài liệu được tổng hợp bởi đội ngũ kỹ thuật của **NPOWER**
Bản quyền nội dung thuộc về **Mitutoyo**

Powered by **NAVITECH** | www.navitech.co

www.npower.com.vn

Gauge Block Calibration

Gauge Block Comparator GBCD-250 Manual Comparator with Dual Gage Heads

- Measuring capability: Rectangular Gauge Blocks; Square Gauge Blocks (requires dedicated holder - optional accessory)
- Measuring method: Differential measurement between upper and lower gaging heads (dual head system)



SPECIFICATIONS

Metric						
Range	Resolution	Accuracy (Confidence level 95%) Comparison measurement of the same nominal length		Accuracy (Confidence level 95%) Dimensional deviations between standard gauge block and measurement gauge block: ±3mm		
0.1mm - 250mm	0.00001mm (0.01µm)	±(0.03+0.3L/1000)µm* L = Gauge block length (mm)		±(0.03+0.3L/1000)µm* L = Gauge block length (mm)		
Upper gage head			Lower gaging head			Operating conditions
Type	Measuring force	Contact point	Type	Measuring force	Contact point	
Laser Hologage	0.7N	Carbide contact point of radius 20mm	Laser Hologage	0.2N	Carbide contact point of radius 5mm	Temperature: 20°C ±1°C Humidity: 58%RH ±15%RH

* Uncertainty of measurement at the 95% confidence level (not including the calibration error of the reference gauge block).

Note: To denote your AC power cable add the following suffixes to the order No.: **A** for UL/CSA, **D** for CEE, **DC** for CCC, **E** for BS, **K** for KC, **No suffix** is required for JIS/100V

Gauge Block Comparator GBCD-100A Automatic Comparator with Dual Gage Heads

- GBCD-100A measures the length of rectangular gauge blocks in the size range 0.5mm to 100mm. It automatically compares a test block with an appropriate reference gauge block.
- The compensation result is not affected by the warp of thinner gauge blocks due to the use of upper and lower gaging heads (dual-head system).
- Measurement configuration: 1 cycle of automatic comparison measurement with a standard gauge block.
- Compensation master for gauge block comparator



Special bridge-type block



SPECIFICATIONS

Metric						
Range	Resolution	Accuracy in narrow range (20°C) ±(0.03+0.3L/1000)µm* L = Gauge block length (mm)	Upper gage head			
			Type	Measuring force	Contact point	
0.5mm - 100mm	0.00001mm (0.01µm)	±(0.03+0.3L/1000)µm* L = Gauge block length (mm)	Mu-Checker	1N (100gf)	Carbide contact point of radius of 20mm	Operating conditions Temperature: 20°C ±1°C Humidity: 58%RH ±15%RH
Lower gaging head			Operating conditions			
Type	Measuring force	Contact point				
Mu-Checker	0.6N (60gf)	Carbide contact point of radius 5mm				

* Uncertainty of measurement at the 95% confidence level (not including the calibration error of the reference gauge block).

Note: To denote your AC power cable add the following suffixes to the order No.: **A** for UL/CSA, **D** for CEE, **DC** for CCC, **E** for BS, **K** for KC, **No suffix** is required for JIS/100V

Automatic Gauge Block Interferometer GBI (Interference fringe analyzing processing)

- Automatic primary-level measuring instrument for gauge block lengths between 0.1mm and 250mm using optical interference. GBI is a Twyman-Green interferometer which employs the method of multiple wavelength coincidence to calibrate lengths more accurately.
- The GBI automatically detects the distribution of interference fringes with a CCD camera and processes the data. Measurement of parallelism and flatness is provided as well as lengths based on the phase shift method and the interference fringe analysis software.
- The intensity and wavelength of the He-Ne laser light sources are highly stable. This allows highly accurate and repeatable measurement.
- Both the refractive index of air and the thermal expansion of gauge blocks are automatically compensated for by computer which is linked to a thermometer, hygrometer and barometer.

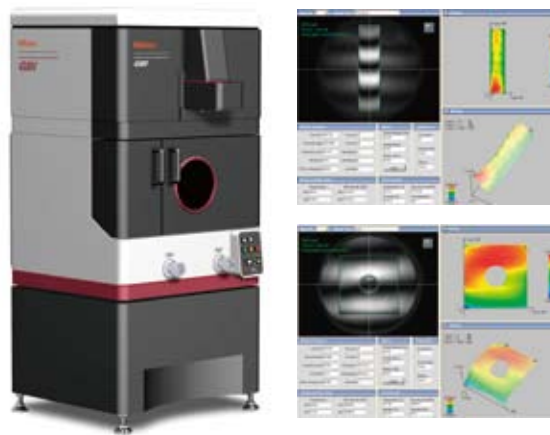

SPECIFICATIONS

Metric				
Range	Measuring Uncertainty (Coverage range factor k = 2)	Number of gauge blocks that can be mounted on the measuring table	Light sources	Operating conditions
0.1mm - 250mm	$0.025\mu\text{m} + 0.2 \times 10^{-6} L$ L = Gauge block length (mm)	12	632.8nm frequency-stabilized He-Ne laser 543.5nm frequency-stabilized He-Ne laser	$20 \pm 0.5^\circ\text{C}$ Under mild temperature change without direct exposure to cold or warm air



Our products are classified as regulated items under Japanese Foreign Exchange and Foreign Trade Law. Please consult us in advance if you wish to export our products to any other country. If the purchased product is exported, even though it is not a regulated item (Catch-All controls item), the customer service available for that product may be affected. If you have any questions, please consult your local Mitutoyo sales office.

- Coordinate Measuring Machines
- Vision Measuring Systems
- Form Measurement
- Optical Measuring
- Sensor Systems
- Test Equipment and Seismometers
- Digital Scale and DRO Systems
- Small Tool Instruments and Data Management



Tài liệu được tổng hợp bởi đội ngũ kỹ thuật của **NPOWER**
 Bản quyền nội dung thuộc về **Mitutoyo**
 Powered by **NAVITECH** | www.navitech.co
www.npower.com.vn

Specifications are subject to change without notice.

Note: All information regarding our products, and in particular the illustrations, drawings, dimensional and performance data contained in this pamphlet, as well as other technical data are to be regarded as approximate average values. We therefore reserve the right to make changes to the corresponding designs, dimensions and weights. The stated standards, similar technical regulations, descriptions and illustrations of the products were valid at the time of printing. Only quotations submitted by ourselves may be regarded as definitive.

Our products are classified as regulated items under Japanese Foreign Exchange and Foreign Trade Law. Please consult us in advance if you wish to export our products to any other country. If the purchased product is exported, even though it is not a regulated item (Catch-All controls item), the customer service available for that product may be affected. If you have any questions, please consult your local Mitutoyo sales office.

Mitutoyo Corporation
 20-1, Sakado 1-Chome,
 Takatsu-ku, Kawasaki-shi,
 Kanagawa 213-8533, Japan
 T +81 (0) 44 813-8230
 F +81 (0) 44 813-8231
<http://www.mitutoyo.co.jp>

