

ジョーを開いた図

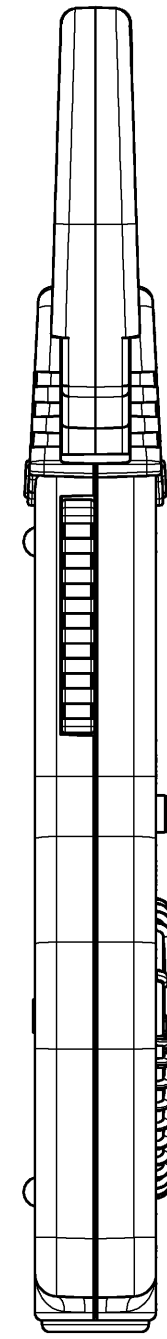

Mesurable cable diameter
測定可能最大導体径
φ33

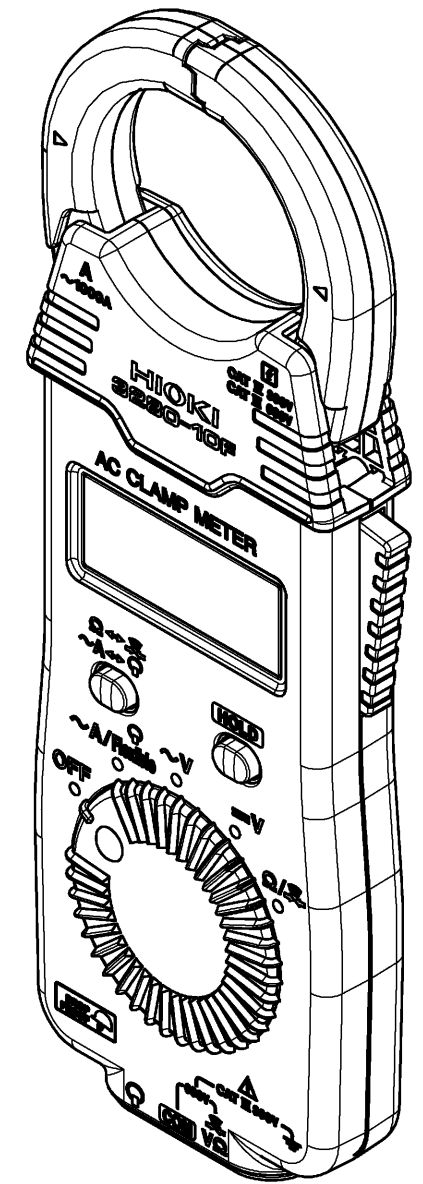
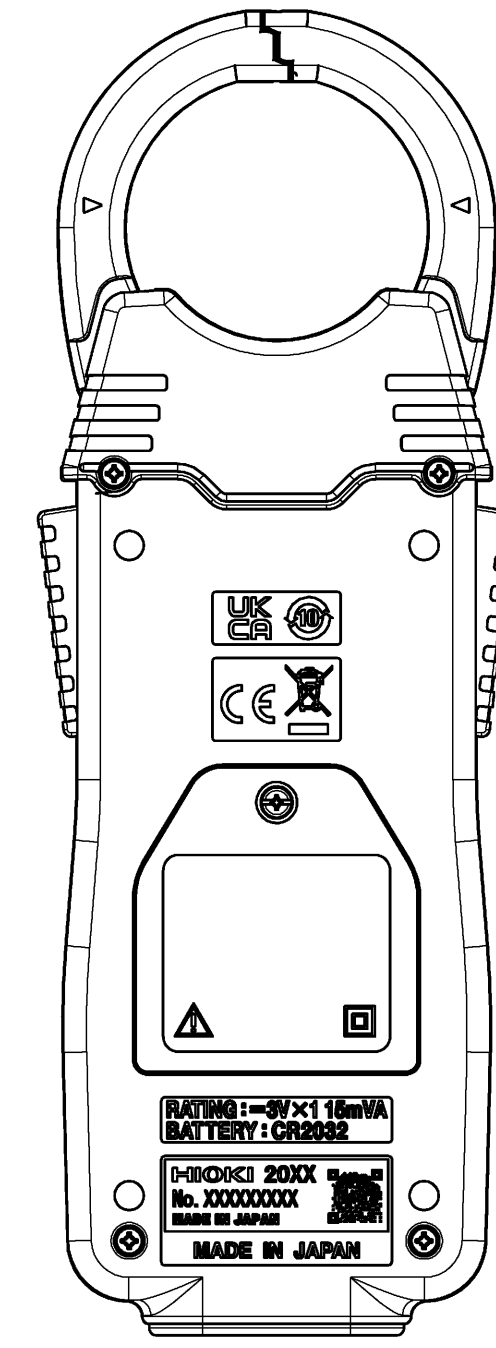
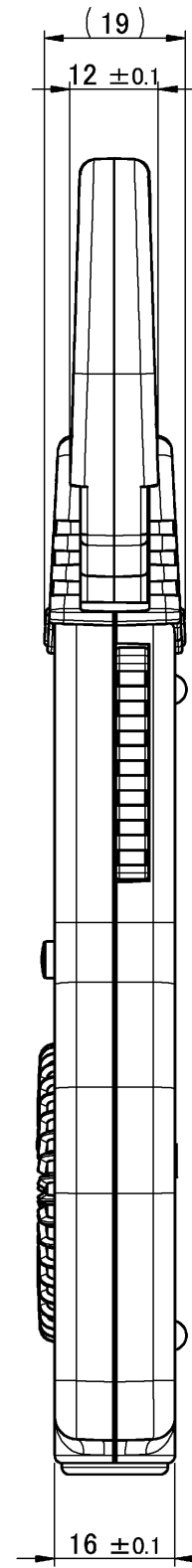
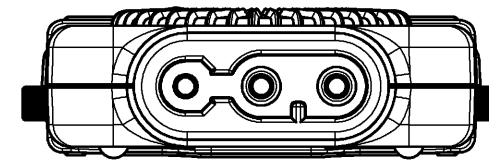
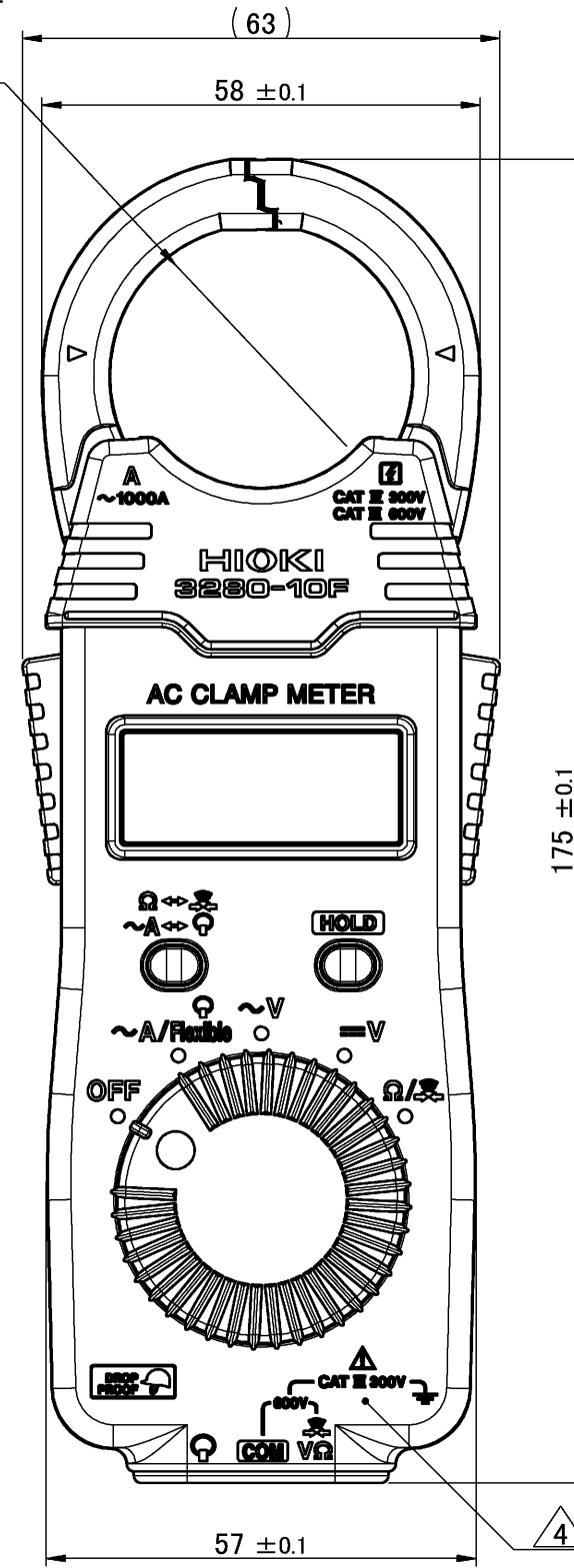
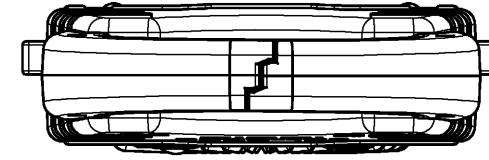

材質 Material	—			承認 Approved by	永井明博		投影法 Projection Method	第一角法		形名 Model	3280-10F	
処理 Finish	—			検図 Checked by	富山和彦		尺度 Scale	1:1		単位 Unit	mm	
初版 Orig.	2023/12/19	荻原伸治	安全規格移行によるシルク表記の変更	設計 Designed by	荻原伸治		シート Sheet	1 / 1		図番 Draw No.	3280H040	
履歴 Sym.	日付 Date	設計 Designed by	注記 Description	版 Rev.	04							