

# INSTRUCTION MANUAL

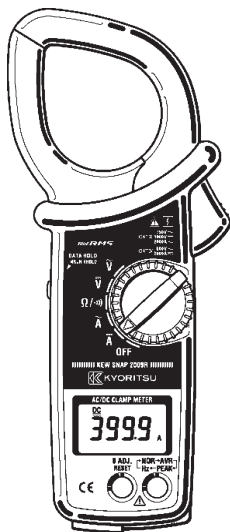

**TRUE***RMS*

---

**DIGITAL CLAMP METER**

---

**KEW SNAP SERIES**

**KEW 2009R**



**KYORITSU ELECTRICAL  
INSTRUMENTS WORKS, LTD.**

---

# Contents

---

|   |    |
|---|----|
| 1. Safety Warnings                          | 1  |
| 2. Features                                 | 5  |
| 3. Specifications                           | 7  |
| 4. Instrument Layout                        | 11 |
| 5. Preparation for Measurement              | 14 |
| 5 – 1 Checking Battery Voltage              | 14 |
| 5 – 2 Checking Switch Setting and Operation | 14 |
| 6. Measurement                              | 15 |
| 6 – 1 DC Current Measurement                | 15 |
| 6 – 2 AC Current Measurement                | 16 |
| 6 – 3 DC Voltage Measurement                | 17 |
| 6 – 4 AC Voltage Measurement                | 18 |
| 6 – 5 Resistance Measurement                | 19 |
| 6 – 6 Continuity Check                      | 20 |
| 6 – 7 Frequency Measurement                 | 20 |
| 6 – 8 Peak Measurement                      | 21 |
| 6 – 9 Average Measurement                   | 23 |
| 7. Other Functions                          | 24 |
| 7 – 1 Auto-power-off Function               | 24 |
| 7 – 2 Data Hold Function                    | 24 |
| 7 – 3 LoHz Function                         | 25 |
| 7 – 4 OUTPUT Terminal                       | 25 |
| 8. Battery Replacement                      | 28 |

---

# 1. Safety Warnings

---

- This instrument has been designed and tested according to IEC Publication 61010: Safety Requirements for Electronic Measuring Apparatus. This instruction manual contains warnings and safety rules which must be observed by the user to ensure safe operation of the instrument and retain it in safe condition. Therefore, read through these operating instructions before starting using the instrument.

## ⚠ WARNING

- Read through and understand instructions contained in this manual before starting using the instrument.
- Save and keep the manual handy to enable quick reference whenever necessary.
- Be sure to use the instrument only in its intended applications and to follow measurement procedures described in the manual.
- Be sure to understand and follow all safety instructions contained in the manual.

Failure to follow the above instructions may cause injury, instrument damage and/or damage to equipment under test.

Kyoritsu is by no means liable for any damage resulting from the instrument in contradiction to this cautionary note.







- The symbol ⚠ indicated on the instrument means that the user must refer to related parts in the manual for safe operation of the instrument. Be sure to carefully read the instructions following each ⚠ symbol in this manual.

⚠ **DANGER** is reserved for conditions and actions that are likely to cause serious or fatal injury.

⚠ **WARNING** is reserved for conditions and actions that can cause serious or fatal injury.

⚠ **CAUTION** is reserved for conditions and actions that can cause minor injury or instrument damage.

Following symbols are used on the instrument and in the instruction manual. Attention should be paid to each symbol to ensure your safety.

|   |   |
|---|---|
|  | Refer to the instructions in the manual.<br>This symbol is marked where the user must refer to the instruction manual so as not to cause personal injury or instrument damage.  |
|  | Indicates an instrument with double or reinforced insulation.   |
|  | Indicates that this instrument can clamp on bare conductors when measuring a voltage corresponding to the applicable Measurement category, which is marked next to this symbol. |
|  | Indicates AC (Alternating Current).   |
|  | Indicates DC (Direct Current).  |
|  | Indicates AC and DC.  |
|  | This instrument satisfies the marking requirement defined in the WEEE Directive. This symbol indicates separate collection for electrical and electronic equipment.             |

### DANGER

- Never make measurement on a circuit above 750VAC/1000VDC.
- Do not attempt to make measurement in the presence of flammable gasses, fumes, vapor or dust. Otherwise, the use of the instrument may cause sparking, which can lead to an explosion.
- Never attempt to use the instrument if its surface or your hand is wet.
- Do not exceed the maximum allowable input of any measurement range.
- Never open the battery compartment cover when making measurement.
- Never try to make measurement if any abnormal conditions, such as broken Transformer jaws or case is noted.
- The instrument is to be used only in its intended applications or conditions. Otherwise, safety functions equipped with the instrument doesn't work, and instrument damage or serious personal injury may be caused.
- Keep your fingers and hands behind the barrier and protective fingerguard during measurement.

**⚠ WARNING**

- Never attempt to make any measurement, if the instrument has any structural abnormality such as cracked case and exposed metal part.
- Do not turn the function selector switch with plugged in test leads connected to the circuit under test.
- Do not install substitute parts or make any modification to the instrument. Return the instrument to Kyoritsu or your distributor for repair or re-calibration.
- Do not try to replace the battery if the surface of the instrument is wet.
- Always switch off the instrument before opening the battery compartment cover for battery replacement.
- Stop using the test lead if the outer jacket is damaged and the inner metal or color jacket is exposed.

**⚠ CAUTION**

- Make sure that the function selector switch is set to an appropriate position before making measurement.
- Always make sure to insert each plug of the test leads fully into the appropriate terminal on the instrument.
- Make sure to remove the test leads from the instrument before making current measurement.
- Do not expose the instrument to the direct sun, extreme temperatures or dew fall.
- Be sure to set the function selector switch to the "OFF" position after use. When the instrument will not be in use for a long period of time, place it in storage after removing the battery.
- Use a damp cloth and detergent for cleaning the instrument. Do not use abrasives or solvents.

## ○ Measurement categories (Over-voltage categories)

To ensure safe operation of measuring instruments, IEC 61010 establishes safety standards for various electrical environments, categorized as 0 to CAT IV, and called measurement categories. Higher-numbered categories correspond to electrical environments with greater momentary energy, so a measuring instrument designed for CAT III environments can endure greater momentary energy than one designed for CAT II.

- O : Circuits which are not directly connected to the mains power supply.
- CAT II : Electrical circuits of equipment connected to an AC electrical outlet by a power cord.
- CAT III : Primary electrical circuits of the equipment connected directly to the distribution panel, and feeders from the distribution panel to outlets.
- CAT IV : The circuit from the service drop to the service entrance, and to the power meter and primary overcurrent protection device (distribution panel).

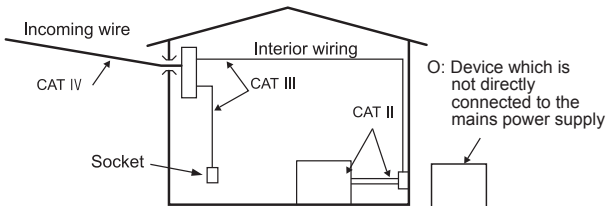

---

## 2. Features

---





- Tear-drop-shaped jaws for ease of use in crowded cable areas and other tight places.
- Accurate true-RMS reading of AC current or voltage with distorted waveform.
- Average function for easy reading of input with large variation.
- Auto-null function for easy zero adjustment.
- Provides frequency reading in AC current or voltage measurement.
- Auto-ranging feature on current, voltage and resistance ranges.
- Wide measuring range from 0 up to 2000A.
- Terminal cover to avoid the use of an incorrect terminal.
- PEAK function for measuring a peak of input
- Provides recorder output for long hour monitoring
- Data Hold function for easy reading in dimly light or hard-to-read locations
- Auto-power-off feature to extend battery life.
- Permits easy continuity check with a beeper
- Provides a dynamic range of 4200 counts full scale
- Wide frequency range from 20Hz to 1kHz
- Uses shrouded transformer jaws to further improve safety
- Designed to CAT IV 600VAC,DC / CAT III 750VAC,1000VDC pollution degree 2 specified by the international safety standard: IEC61010-1.

## \*Effective Value (RMS)

Most alternating currents and voltages are expressed in effective values, which are also referred to as RMS (Root-Mean-Square) values.

The effective value is the square root of the average of square of alternating current or voltage values.

Many clamp meters using a conventional rectifying circuit have "RMS" scales for AC measurement. The scales are, however, actually calibrated in terms of the effective value of a sine wave though the clamp meter is responding to the average value. The calibration is done with a conversion factor of 1.111 for sine wave, which is found by dividing the effective value by the average value. These instruments are therefore in error if the input voltage or current has some other shape than sine wave.

| Waveform   | Effective value<br>Vrms                  | Average value<br>Vavg               | Conversion<br>factor<br>Vrms/ Vavg            | Reading errors for<br>average sensing<br>instrument  | Crest factor<br>CF                          |
|--|--|-------------------------------------|---|--|---|
|   | $\frac{1}{\sqrt{2}} A$<br>$\doteq 0.707$ | $\frac{2}{\pi} A$<br>$\doteq 0.637$ | $\frac{\pi}{2\sqrt{2}}$<br>$\doteq 1.111$     | 0%   | $\sqrt{2}$<br>$\doteq 1.414$                |
|   | A  | A                                   | 1   | $\frac{A \times 1.111 - A}{A} \times 100$<br>$= 11.1\%$                                      | 1   |
|   | $\frac{1}{\sqrt{3}} A$                   | 0.5A                                | $\frac{2}{\sqrt{3}}$<br>$\doteq 1.155$        | $\frac{0.5A \times 1.111 - \frac{A}{\sqrt{3}}}{\frac{A}{\sqrt{3}}} \times 100$<br>$= -3.8\%$ | $\sqrt{3}$<br>$\doteq 1.732$                |
|  | $A \sqrt{D}$                             | $A \frac{f}{T} = A \cdot D$         | $\frac{A \sqrt{D}}{A D} = \frac{1}{\sqrt{D}}$ | $(\frac{1.111 \sqrt{D}}{1} - 1) \times 100\%$  | $\frac{A}{A \sqrt{D}} = \frac{1}{\sqrt{D}}$ |

\*CF (Crest Factor) is found by dividing the peak value by the effective value.

Examples:

DC: CF=1

Sine wave: CF=1.414

Square wave with a 1: 10 duty ratio: CF=3



### 3. Specifications

- Measuring Ranges and Accuracy (at 23 °C ± 5 °C , relative humidity 75% or less)

AC Current  $\tilde{A}$  (RMS value detection, Auto-range)

| Range | Display range | Allowable input | Accuracy*<br>(Frequency)             |
|-------|---------------|-----------------|--------------------------------------|
| 400A  | 0.0~420.0A    | 1.0~1700Arms    | ±1.3%rdg±3dgt<br>(45~66Hz)           |
| 2000A | 150~2100A     |                 | 1700~2000Arms<br>(3000Apeak or less) |
|       |               |                 | ±2.3%rdg±3dgt<br>(45~66Hz)           |

※For non-sinusoidal waveforms, add ±(1.5% of full scale), for Crest factor<3.

※4 counts or less is corrected to 0

DC Current  $\bar{A}$ , Auto-range

| Range | Display range | Allowable input | Accuracy               |
|-------|---------------|-----------------|------------------------|
| 400A  | ±0.0~420.0A   | 0.0~±2000A      | ±1.3%rdg±2dgt          |
| 2000A | ±150~2100A    |                 | After zero adjustments |

AC Voltage  $\tilde{V}$  (RMS value detection, Auto-range)

| Range | Display range | Allowable input                     | Accuracy*<br>(Frequency)   |
|-------|---------------|-------------------------------------|----------------------------|
| 40V   | 0.00~42.00V   | 0.00~750Vrms<br>(1200Vpeak or less) | ±1.0%rdg±2dgt<br>(45~66Hz) |
| 400V  | 15.0~420.0V   |                                     | ±1.5%rdg±5dgt              |
| 750V  | 150~788V      |                                     | (20Hz~1kHz)                |

※Input Impedance : approx. 2MΩ <200pF

※For non-sinusoidal waveforms, add ±(1.5% of full scale), for Crest factor<3.

※4 counts or less is corrected to 0

DC Voltage  $\bar{V}$  (Auto-range)

| Range | Display range | Allowable input | Accuracy      |
|-------|---------------|-----------------|---------------|
| 40V   | 0.00~±42.00V  | 0.00~±1000V     | ±1.0%rdg±2dgt |
| 400V  | ±15.0~±420.0V |                 |               |
| 1000V | ±150~±1050V   |                 |               |

※Input Impedance : approx. 2MΩ

Resistance / Continuity  $\Omega/\text{diode}$  (Auto-range)

| Range | Display range | Allowable input | Accuracy      |
|-------|---------------|-----------------|---------------|
| 400Ω  | 0.0 ~ 420.0Ω  | 0.0Ω ~ 4000Ω    | ±1.5%rdg±2dgt |
| 4000Ω | 150 ~ 4200Ω   |                 |               |

※Open-loop Voltage : approx.3V, Measuring Current : 0.6mA or less (400Ωrange) 0.06mA or less(4000Ωrange)

※The buzzer turns on for resistances lower than 20±1Ω.

Frequency Hz ( AC Current) (Auto-range)

| Range  | Display range | Allowable input | Accuracy      |
|--------|---------------|-----------------|---------------|
| 1000Hz | 8.0 ~ 999.9Hz | 10.0Hz ~ 1000Hz | ±1.5%rdg±5dgt |
| 4000Hz | 900 ~ 4200Hz  | 1000 ~ 4000Hz   | ±1.5%rdg±5dgt |

Frequency Hz (AC Voltage) (Auto-range)

| Range  | Display range | Allowable input | Accuracy      |
|--------|---------------|-----------------|---------------|
| 1000Hz | 8.0 ~ 999.9Hz | 10.0Hz ~ 1000Hz | ±1.5%rdg±5dgt |
| 4000Hz | 900 ~ 4200Hz  | 900 ~ 4000Hz    | ±1.5%rdg±5dgt |

Output      Output voltage : 0.1mV / 1 count

| Range   | Allowable input | Output Voltage (mVDC) | Accuracy                                   |
|---------|-----------------|-----------------------|--|
| DC400A  | 0.0~±400.0A     | 0~±400mV              | Within ±1mV<br>(To the indicated<br>value) |
| DC2000A | 0~±2000A        | 0~±200mV              |  |
| AC400A  | 0.0~400.0A      | 0~400mV               |  |
| AC2000A | 0~2000A         | 0~200mV               |  |

※When the display is "OL", the output voltage is 420mV ("OL" : -420mV)

※Output impedance: about 10kΩ

Note:◇The symbol of "—" in the above table means that the instrument only displays the value, but the accuracy, the proper operation and the safety are not guaranteed.

- Operating System
- Display
  - $\Delta \Sigma$  modulation
  - Liquid crystal display with a maximum count of 4200 plus annunciators
  - "OL" is shown on the display
  - Approx. 2 seconds.
  - About 3 times per second.
  - IEC 61010-1, 61010-2-032, 61010-2-033, 61010-031 CAT IV 600V / CAT III 1000V Pollution degree 2
  - EN 61326-1, EN61326-2-2
  - EU RoHS directive compliant
  - Indoor / outdoor use, Altitude up to 2000m
  - 23 +/-5°C , relative humidity up to 75% without condensation
  - 0-40°C , relative humidity up to 85% without condensation
  - 20-60°C , relative humidity up to 85% without condensation
  - Two 1.5VDC R6P (SUM-3) batteries
  - Approx. 40mA max (ACA).
  - Automatically powered down in about 10 minutes after the last switch operation
  - (power consumption: about 200  $\mu$  A)
- Overrange Indication
- Response Time
- Sample Rate
- Safety standard
- EMC
- Environmental standards
- Location for use
- Temperature and Humidity for Guranteed Accuracy
- Operating Temperature and Humidity
- Storage Temperature and Humidity
- Power Source
- Current Consumption
- Auto-power-off function
- Overload Protection
  - DC/AC current ranges:
  - 2400A AC for 10sec
  - DC/AC voltage ranges:
  - 1200V AC/DC for 10sec
  - Resistance range:
  - 1000V AC/DC for 10sec
- Withstand Voltage
  - 7000V AC, 50/60Hz for 5 seconds between electrical circuit and housing case or metal part of the jaws
- Insulation Resistance
  - 10M $\Omega$  or greater at 1000V between electrical circuit and housing case or metal part of the jaws
- Conductor Size
- Dimensions
- Weight
- Accessories
  - Approx. 55mm diameter max.
  - 250(L)x105(W)x49(D)mm
  - About 540g
  - Test leads M-7107A
  - R6P battery
  - Carrying case M-9094
  - Instruction manual
  - Output Lead M-7256.
- Optional Accessories

## 4. Instrument Layout

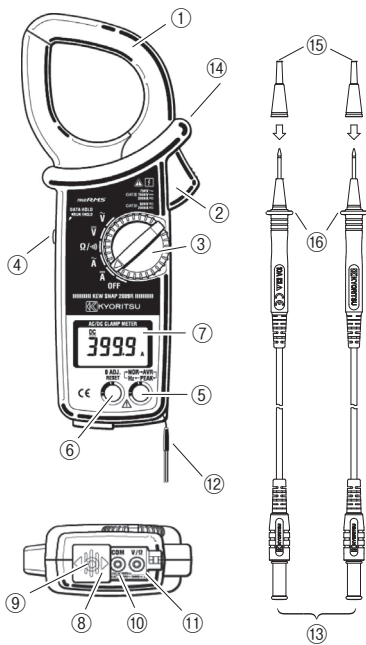

① Transformer Jaws

Pick up current flowing through the conductor.

② Jaw Trigger

Operates the transformer jaws. Press to open the Transformer Jaws.

③ Function Selector Switch

Selects function. Also used to power the instrument on.

④ Data Hold Button

Freezes the display reading. "H" is shown on the display when Data Hold is enabled.

When the output lead is inserted into the output terminal, Data Hold Switch operates as range selection switch. (See 7-4 output terminal)

### ⑤ Mode Selector Button

Selects measuring mode. The instrument defaults to the normal mode (NOR). Then, press this switch to cycle through measuring modes. In any mode, pressing this switch for more than one second returns the instrument to the normal mode.

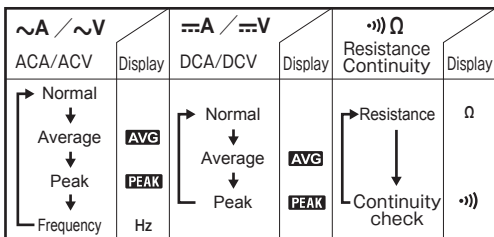

### ⑥ Zero Adjust/Reset Button

Used for zero adjustment on DCA and resistance ranges. Also used to reset the display reading in the PEAK mode. On DCA range, "AUTO" is shown on the display when auto-zeroing is completed. (Auto-zeroing is available on 400A range only.)

### ⑦ Digital Display

Field effect digital display with maximum reading of 4200. Function symbols and decimal point are controlled by the microprocessor based on the selected function and measuring mode.

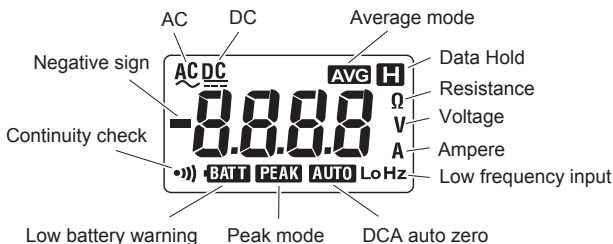

⑧ Terminal Cover

Slides over V/ $\Omega$  and COM Terminals to prevent access to them when OUTPUT terminal is in use.

⑨ OUTPUT Terminal (For AC or DC current range only)

Provides DC voltage output in proportion to the AC or DC current reading. The output is connected to a recording device such as a chart recorder for long hour monitoring. No output is available on voltage and resistance ranges.

⑩ COM Terminal

Accepts the black test lead for voltage or resistance measurement.

⑪ V/ $\Omega$  Terminal

Accepts the red test lead for voltage or resistance measurement.

⑫ Safety Hand Strap

Prevents the instrument from slipping off the hand during use.

⑬ Test Leads (Model 7107A)

Connected to COM and V/ $\Omega$  terminals for voltage or resistance measurement.

⑭ Barrier/ ⑯ Protective fingerguard

It is a part providing protection against electrical shock and ensuring the minimum required air and creepage distances.

⑮ Test Lead Cap

Uncapped condition for CAT II environment

Capped condition for CAT III/ IV environments

The Cap should be firmly attached to the probes.

Test leads can be used under the CAT II and CAT III and CAT IV environments by attaching a protective cap as illustrated below. Use of our protective cap offers different lengths suitable for the test environments.

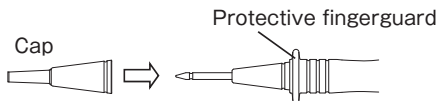

When the instrument and the test lead are combined and used together, whichever lower category either of them belongs to will be applied.

---

## 5. Preparation for Measurement

---

### 5 – 1 Checking Battery Voltage

- ① Set the function selector switch to any position other than "OFF".
- ② When the display is clear without "BATT" showing, proceed to measurement.
- ③ When the display blanks or "BATT" is indicated, replace the battery according to section 8. Battery Replacement.

#### NOTE

- The Auto-power-off feature automatically turns the instrument off in about 10 minutes after the last switch or button operation. Therefore, the display may be blank even with the function selector switch set to a position other than "OFF". To operate the instrument in this case, turn the switch back to the "OFF" position, then to any other position.

### 5 – 2 Checking Switch Setting and Operation

Make sure that the function selector switch is set to the correct position, the instrument is set to the correct measuring mode and the Data Hold function is disabled. Otherwise, desired measurement cannot be made. (See section 6 for measurement instructions and section 7 for notes on functions.)



## 6. Measurement

### 6-1 DC Current Measurement

#### ⚠ DANGER

- Do not make measurement on a circuit above 1000VDC. This may cause shock hazard or damage to the instrument or equipment under test.
- Do not make measurement with the battery compartment cover removed from the instrument.
- Do not make current measurement with the test leads connected to the V/ $\Omega$  and COM terminals.
- Keep your fingers and hands behind the barrier during measurement.

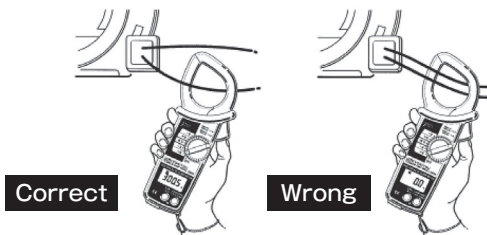

- ① Set the function selector switch to the " $\text{DC A}$ " position. "DC" should be shown on the upper left corner of the display.
- ② With the transformer jaws closed and without clamping them onto the conductor, press the Zero Adjust/Reset button for about one second to zero adjust the display. (Zero adjust feature is for 400A range only.) When zero adjustment is completed, "AUTO" appears on the display.
- ③ Press the trigger to open the transformer jaws and clamp them onto the conductor under test, then take the reading on the display. The most accurate reading will be obtained by keeping the conductor at the center of the transformer jaws.

## NOTE

- During current measurement, keep the transformer jaws fully closed. Otherwise, accurate measurement cannot be made. The maximum measurable conductor size is approx. 55mm in diameter.
- When the current flows from the upside (the display side) to the underside of the instrument, the reading is indicated positive.
- The Zero Adjust/Reset button may not completely zero adjust the output voltage from the OUTPUT terminal. In this case, make zero adjustment on the recording device.
- Turning the function selector switch to a position other than DCA cancels the zero adjustment.

## 6-2 AC Current Measurement

### **⚠ DANGER**

- Never use the instrument on a circuit above 750VAC. This may cause electrical shock hazard and damage to the instrument or the circuit under test.
- Do not make measurement with the test leads plugged into the instrument.
- Do not make measurement with the battery compartment cover removed.
- Keep your fingers and hands behind the barrier during measurement.

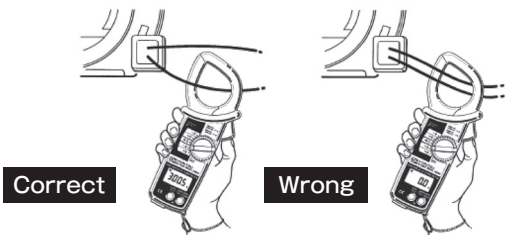

- ① Set the function selector switch to the " $\sim$  A" position. "AC" should be shown on the upper left corner of the display.
- ② Press the trigger to open the transformer jaws and clamp them onto a single conductor and take the reading on the display. The most accurate reading will be obtained by keeping the conductor at the center of the transformer jaws.

#### NOTE

- During current measurement, keep the transformer jaws fully closed. Otherwise, accurate measurements cannot be taken. Maximum conductor size is 55mm in diameter.
- Zero adjustment is not necessary in AC current measurement.
- When the current under test measures 3% of the range or less, "LoHz" is indicated on the display.

### 6-3 DC Voltage Measurement

#### **⚠ DANGER**

- Never use the instrument on a circuit above 1000VDC. This may cause electrical shock hazard and damage to the instrument or the circuit under test.
- Do not make measurement with the battery compartment cover removed.
- Keep your fingers and hands behind the protective fingerguard during measurement.

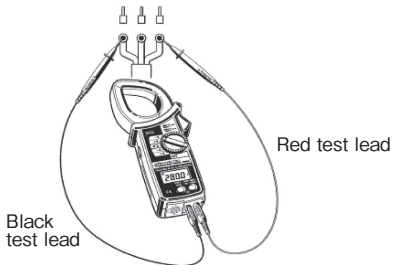

- ① Set the function selector switch to the " $\text{DC} \text{ V}$ " position. "DC" should be shown on the upper left corner of the display.
- ② Slide the terminal cover to the left to disclose the  $\text{V}/\Omega$  and COM terminals. Plug the red test lead into the  $\text{V}/\Omega$  terminal and the black test lead into COM terminal.
- ③ Connect the tip of the red and black test leads to the positive (+) and negative (-) sides of the circuit under test respectively. Take the reading on the display. If the connection is reversed, the display indicates the "-" sign.

## 6 – 4 AC Voltage Measurements

### **⚠ DANGER**

- Never use the instrument on a circuit above 750VAC. This may cause electrical shock hazard and damage to the instrument or the circuit under test.
- Do not make measurement with the battery compartment cover removed.
- Keep your fingers and hands behind the protective fingerguard during measurement.

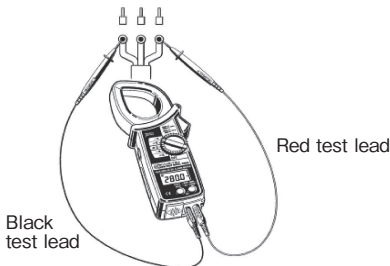

- ① Set the function selector switch to the " $\sim \text{V}$ " position. "AC" should be shown on the upper left corner of the display.
- ② Slide the terminal cover to the left to disclose the  $\text{V}/\Omega$  and COM terminals. Plug the red test lead into  $\text{V}/\Omega$  terminal and the black test lead into the COM terminal.

- ③ Connect the tip of the red and black test leads to the circuit under test and take the reading on the display.

#### NOTE

- When the voltage under test measures 3% of the range or less, or the frequency of the voltage is low, "LoHz" is indicated on the display.

## 6 – 5 Resistance Measurement

### ⚠ DANGER

- Never use the instrument on an energized circuit.
- Do not make measurement with the battery compartment cover removed.
- Keep your fingers and hands behind the protective fingerguard during measurement.

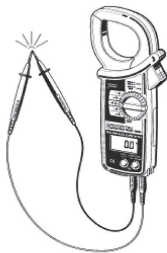

- ① Set the function selector switch to the " $\Omega$ " position.
- ② Slide the terminal cover to the left to disclose the V/ $\Omega$  and COM terminals. Plug the red test lead into the V/ $\Omega$  terminal and the black test lead into the COM terminal.
- ③ With the tip of the test leads shorted together, press the Zero Adjust/Reset button to offset the resistance of the test leads.
- ④ Connect the tip of the test leads to the circuit under test and take the reading on the display.

## 6 – 6 Continuity Check (400Ω range fixed)

※The continuity check mode is enabled by pressing the mode selector switch on resistance range. " •)) " is indicated on the display to show the instrument in the continuity check mode. The buzzer beeps, if the resistance under test is 20.0Ω or less.

### **⚠ DANGER**

- Never use the instrument on an energized circuit.
- Do not make measurement with the battery compartment cover removed.
- Keep your fingers and hands behind the protective fingerguard during measurement.

- ① Set the function selector switch to the " •)) Ω " position.
- ② Slide the terminal cover to the left to disclose the V/Ω and COM terminals. Plug the red test lead into the V/Ω terminal and the black test lead into the COM terminal.
- ③ With the tip of the test leads shorted together, press the Zero Adjust/Reset button to offset the resistance of the test leads.
- ④ Press the mode selector button once to enter from the normal mode to the continuity check mode. " •)) " should be indicated on the display.
- ⑤ Connect the tip of the test leads to the circuit under test. If the resistance is 20.0Ω or less, the buzzer beeps.

## 6 – 7 Frequency Measurement

- On ACA or ACV range, the frequency of the current or voltage under test can be counted and shown on the display.
- In the frequency measurement mode, "Hz" is indicated on the display.
- Trigger threshold is approx. 10V for AC voltage and approx. 40A for AC current.

**⚠ DANGER**

- Never use the instrument on a high voltage circuit above 750VAC.

This may cause electrical shock hazard and damage to the instrument or the circuit under test.

- Do not make measurement with the battery compartment cover removed.
- Do not make current measurement with the test leads plugged into the instrument.
- Keep your fingers and hands behind the protective fingerguard during measurement.

- ① Set the function selector switch to the " $\sim$  A" or " $\sim$  V" position.
- ② Press the mode selector button three times to enter from the normal mode to the frequency measurement mode. "Hz" should be indicated on the display.
- ③ Follow instructions for ACA or ACV measurement and take the frequency reading.

**NOTE**

- When the voltage under test measures 3% of the range or less, or the frequency of the current or voltage is 40Hz or less, "LoHz" is indicated on the display.

**6 – 8 Peak Measurement**

- In the PEAK mode, the display shows current or voltage's crest in effective value. (For example, when the current or voltage is sinusoidal, the reading equals the crest value divided by the square root of two.)  
The display reading is constantly updated with a maximum crest.
- In this mode, "PEAK" is indicated on the display.
- Response time is 300ms in DC measurement and 10ms in AC measurement.

**⚠ DANGER**

- Never use the instrument on a circuit above 750VAC/1000VDC. This may cause electrical shock hazard and damage to the instrument or the circuit under test.
- Do not make measurement with the battery compartment cover removed.
- Do not make measurement with the test leads plugged into the instrument.
- Keep your fingers and hands behind the protective fingerguard during measurement.

① The PEAK mode is available on DCA, ACA, DCV and ACV ranges.

Set the function selector switch to the desired position.

Note : Only on DCA range, press the Zero Adjust/Reset button for about one second to zero adjust the reading with the transformer jaws closed.

- ② Press the mode selector button twice to enter from the normal mode to the PEAK mode. "PEAK" should be shown on the display.
- ③ Follow instructions for DCA, ACA, DCV or ACV measurement.

INPUT Current

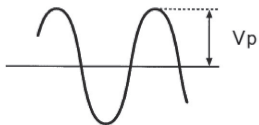

Peak Hold



Note : For accurate reading, press the Zero Adjust/Reset button to reset the reading after clamping onto the conductor or making test lead connections to the circuit under test. Then, proceed to measurement.



## NOTE

- In the PEAK mode, the auto-ranging feature is disabled and measuring ranges are fixed as follows.  
DC/ACA: 0-400.0A  
DC/ACV: 0-400.0A
- When a measured value is 9 counts or less, it is corrected to 0
- The Auto-power-off function is disabled in the PEAK mode as well.

## 6 – 9 Average Measurement

- In the Average mode, "AVG" is indicated on the display.
- The display reads a running average of six readings over an interval of about 2 seconds.
- This mode is available on ACV, DCV, ACA and DCA ranges.
  - ① Set the function selector switch to the desired position.
  - ② Press the mode selector button once to enter from the normal mode to the Average mode. " **AVG** " should be indicated on the display.
  - ③ Follow instructions for ACV, DCV, ACA or DCA measurement.
  - ④ The display shows a running average of six readings over an interval of about 2 seconds.

---

## 7. Other Functions

---

### 7 – 1 Auto-power-off Function

⚠ CAUTION

- The instrument consumes small amount of battery power in the Auto-power-off mode. Make sure to set the function selector switch to the OFF position after use.

This is a function to prevent the instrument from being left powered on in order to conserve battery life. This function causes the instrument to enter the Auto-power-off mode about 10 minutes after the last switch or button operation.

To exit the Auto-power-off mode, turn the function selector switch back to "OFF", then to any other position, or press any button.

#### NOTE

- Connecting the output lead to the OUTPUT terminal disables the Auto-power-off function. The function is enabled on removing the output lead from the terminal.
- The Auto-power-off function is disabled in the PEAK measurement mode.

### 7 – 2 Data Hold Function

This is a function used to freeze the measured value on the display.

Press the Data Hold button to freeze the reading. The reading will be held regardless of subsequent variation in input. " **H** " is shown on the upper right corner of the display while the instrument is in the Data Hold mode.

To exit the Data Hold mode, press the Data Hold button again.

## NOTE

- If the instrument in the Data Hold mode goes into "Auto-power-off," it will return to the normal mode.

### 7 – 3 LoHz Function

In ACV or ACA range, if frequency of the voltage or current under test is 40Hz or lower, the display indicates "LoHz".

"LoHz" is also indicated where input is 3% of range or less.

### 7 – 4 OUTPUT Terminal (For current ranges only)

#### **DANGER**

- Never use the instrument on a circuit above 750VAC/1000VDC. This may cause electrical shock hazard and damage to the instrument or the circuit under test.
- Do not make measurement with the battery compartment cover removed.
- Never apply voltage to the OUTPUT terminal.

- ① Slide the terminal cover to the right to disclose the OUTPUT terminal and insert the output lead into the terminal. Make connection to the recording device.

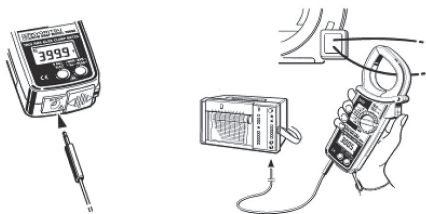

- ② When the lead is inserted into the output terminal, auto-range function is cleared.

Set the range depending on the state of Data Hold Switch.

Data Hold Switch OFF 400A range

Data Hold Switch ON 2000A range

Note : After measurement, be sure to return Data Hold Switch to OFF position.

- ③ Set the function selector switch to the desired position (ACA or DCA) and follow appropriate measurement instructions.

#### NOTE

- During current measurement, keep the transformer jaws fully closed. Otherwise, accurate measurement cannot be made. The maximum measurable conductor size is approx. 55mm in diameter.
- Zero adjustment is not necessary on AC current range.
- On DC current range, the Zero Adjust/Reset button may not completely zero adjust the output voltage from the OUTPUT terminal. In this case, make zero adjustment on the recording device.
- Connecting the output lead to the OUTPUT terminal disables the Auto-power-off function. The function is enabled on removing the output lead from the terminal.

- Consult the output voltage specifications shown in section 3 and adjust the sensitivity of the recording device.
- For long hours of use of the OUTPUT terminal, use an Alkaline battery, which will extend continuous recording time up to about 35 hours.

---

## 8. Battery Replacement

---

### ⚠ WARNING

- To avoid electric shock hazard, make sure to set the function selector switch to "OFF" and remove the test leads from the instrument before trying to replace battery.

### ⚠ CAUTION

- Do not mix new and old battery.
- Make sure to install battery in correct polarity as indicated in the battery compartment.

If the battery voltage becomes too low for the instrument to operate normally, " **BATT** " is shown on the display. Then, replace the battery. Note that when the battery is completely exhausted, the display blanks without " **BATT** " shown.

- ① Set the function selector switch to the "OFF" position.
- ② Unscrew and remove the battery compartment on the bottom of the instrument.
- ③ Replace the battery observing correct polarity. Use a new R6P or equivalent battery.
- ④ Re-place and screw the battery compartment cover.

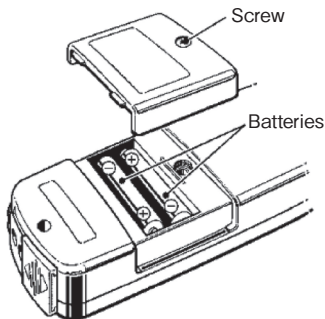

Memo



DISTRIBUTOR

Kyoritsu reserves the rights to change specifications or designs described in this manual without notice and without obligations.



**KYORITSU ELECTRICAL  
INSTRUMENTS  
WORKS, LTD.**

2-5-20, Nakane, Meguro-ku,  
Tokyo, 152-0031 Japan  
Phone: +81-3-3723-0131  
Fax: +81-3-3723-0152  
Factory: Ehime, Japan

**[www.kew-ltd.co.jp](http://www.kew-ltd.co.jp)**