

INSTRUCTION MANUAL

PORTABLE MAGNETIC DRILL

READ ALL INSTRUCTIONS BEFORE OPERATING THIS MACHINE TOOL

ATRA ACE Model QA-4000, QA-6500

PROFESSIONAL TOOL For One-touch Type Annular Cutter Only

(Side Lock Type Annular Cutter Cannot Be Fitted)



QA-4000



QA-6500

Specifications

Model		QA-4000	QA-6500
Power Source (Single Phase)		220 - 240 V AC 50 / 60 Hz	220 - 240 V AC 50 / 60 Hz
Drill Motor	Rated Power Consumption	680 W	1010 W
	Rated Ampere	3 A	4.5 A
	No-load Speed	750 min ⁻¹ (rpm)	400 / 750 min ⁻¹ (rpm)
Magnet Power Consumption		50 W	75 W
Hole Capacity	Jetbroach One-touch Type	Hole Diameter : 17.5 to 40 mm Max. Plate thickness : 35 mm	Hole Diameter : 17.5 to 40 mm Max. Plate thickness : 35 mm 17.5 to 65 mm Max. Plate thickness : 50 mm
	Hibroach One-touch Type	Hole Diameter : 14 to 15 mm Max. Plate thickness : 12 mm Hole Diameter : 16 to 18 mm Max. Plate thickness : 25 mm	Hole Diameter : 18 to 35 mm Max. Plate thickness : 25 mm
Magnet Holding Power		6664 N (680 kgf)	9800 N (1000 kgf)
Magnet Dimensions		82 mm × 172 mm	100 mm × 200 mm
Weight		18.5 kg	26 kg

The specifications and design may be changed for improvement without prior notice.



Manufactured by:

NITTO KOHKI Co., Ltd.

2-9-4, Nakaikegami, Ohta-ku,

Tokyo 146-8555, Japan

TEL : (81)-3-3755-1111

FAX : (81)-3-3753-8791

E-mail : overseas@nitto-kohki.co.jp

URL : www.nitto-kohki.co.jp

Keep the manual handy – so you can use it whenever necessary.

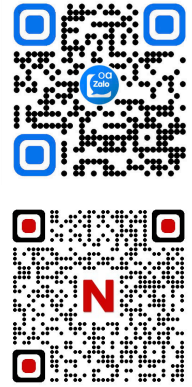

Thank you for purchasing **Nitto Kohki** product.
Before using this tool, please read this manual carefully to ensure proper, efficient operation.
This instruction manual should be kept close at hand.

www.npower.com.vn

Tài liệu được tổng hợp bởi đội ngũ kỹ thuật của **NPOWER**
Bản quyền nội dung thuộc về **NITTO KOHKI**
Powered by **NAVITECH** | www.navitech.co

CONTENTS

IMPORTANT SAFETY INSTRUCTIONS FOR ALL ELECTRIC TOOLS	2
IMPORTANT SAFETY INSTRUCTIONS FOR PORTABLE MAGNETIC DRILL	3
1. USAGE	6
2. CHECK THE CONTENTS OF THE PACKAGE	6
3. NAME OF PARTS	6
4. ELECTRIC CONTROL FUNCTIONS	7
5. PREPARATION	7
6. HOW TO OPERATE THE TOOL	11
7. TROUBLESHOOTING	14
8. MAINTENANCE AND INSPECTION	15
9. ORDERING SERVICE PARTS	17

PICTOGRAPH



Warning: It might be dangerous to operate the power tool if the instructions supplied are not followed.



Before operating the tool, read and understand all the instructions supplied. Keep it for future reference.



Personal protective equipment as eye and ear protection and protective gloves must always be used when operating the tool.

WARNING

IMPORTANT SAFETY INSTRUCTIONS FOR ALL ELECTRIC TOOLS

When using electric tools, basic safety precautions should always be followed to reduce risk of fire, electric shock, personal injury and the like, including the following.

(1) Keep work area clean.

- Cluttered work areas and benches invite accidents and injuries.

(2) Consider work area environment.

- Do not expose tools to rain. Do not use tools in damp or wet locations.
- Keep work area well lit.
- Do not operate near flammable liquids or in gaseous or explosive atmospheres.

(3) Check the Power Source

- Operate under the power source the voltage fluctuating rate of which is within $\pm 10\%$ of the rated voltage, and the frequency of which is 50/60Hz of sinusoidal wave.

(4) Be cautious about electric shock.

- When using electric tools, do not touch any which is earthed. (Ex. Pipe, heating apparatus, microwave oven, outside frame of refrigerator)

(5) Keep children away.

- Also all visitors should be kept away from work area.
- Do not let visitors contact the tool, or connecting cords.

(6) Store idle tools.

- When not in use, tools should be stored in dry, and locked-up places out of reach of children.

(7) Do not force tool.

- It will do the job better and safer at the rate which it was designed.

(8) Use right tool.

- Do not force a small tool of attachment to do the job of a heavy-duty tool.
- Do not use tool for a purpose not intended.

(9) Dress properly.

- Do not wear loose clothing or accessories. They can be caught in moving parts.
- Rubber gloves and Non-skid footwear are recommended.
- Wear protective hair covering to contain long hair.

(10) Always wear eye protection.

- Everyday eyeglasses only have impact resistant lenses. They do NOT protect eyes. Also use face or dust mask, if operations create dust.

(11) Do not abuse cable.

- Never carry tool by connecting cable or yank it to disconnect from receptacle.
- Do not place a cable near a place with high heat, oil, and sharp edge.

(12) Secure work.

- Use clamps or a vise to hold work when practical.
- It is safer than using your hand and it frees both hands to operate tool.

(13) Do not overreach.

- Keep proper footing and balance at all times.

(14) Cautious maintenance is necessary for electric tools.

- Always maintain blades and keep it work well so that safe and efficient work can be done.
- Follow the instruction manual for oiling or change of accessories.
- Check the cable regularly. Contact the sales agents to repair it when it is defective.
- When an extension cable is used, check regularly and change it when it is damaged.
- The grip should be kept dry and clean. Maintain it so well that it does not carry oil or grease.

(15) Switch off and take off the plug for the following:

- Not in use.
- When you change blades, grinding stone and bit.
- Any danger is anticipated.

(16) Remove spanners, wrenches etc., after adjustment.

- Make sure that spanners, wrenches etc., which are used for adjustment are removed before switching on.

(17) Always avoid unexpected start.

- Do not carry the tool with a finger on the switch when the power supply is on. Make sure that the switch is off before plugging in.

(18) Use a cabtyre cable or a cabtyre extension cable when it is used outside.

(19) Stay alert.

- Watch what you are doing.
- Bear in mind the way of handling/operation and the circumstances of the surrounding area.
- Use common sense.
- Do not operate tool when you are tired.

(20) Check damaged parts.

- Before further use of the tool, an accessory or other part that is damaged should be carefully checked to determine that it will operate properly and perform its intended functions.
- Check for alignment of moving parts, binding of moving parts, breakage of parts, mounting and any other conditions that may affect its operation.
- An accessory or other part that is damaged or inoperable should be properly repaired or replaced. When a switch becomes out of order, repairs should be performed only by the sales agent from whom you purchased the tool or an authorized dealer.
- Do not use electric tools which cannot be activated or stopped with a switch.

(21) Use recommended accessories.

- Consult this manual or the sales agent from whom you purchased the tool or an authorized dealer for recommended accessories. The use of improper accessories may cause risk of injury to persons.

(22) Repairs by authorized personnel.

- This tool should not be modified as it meets safety requirements.
- Any repairs to the tool or installation of replacement parts should be performed only by the sales agent from whom you purchased the tool or an authorized dealer.
- Failure to utilize the expertise of the sales agent from whom you purchased the tool or an authorized dealer or, failure to use genuine replacement parts, may result in an increased risk of injury to the user and may invalidate your warranty.

⚠ WARNING

IMPORTANT SAFETY INSTRUCTIONS FOR PORTABLE MAGNETIC DRILL

- **Use of power is limited to the power source specified by the rating plate.**
- **Do not use the power supply for the engine powered welder.**
- **The earth lead must not be connected to a gas pipe. This may cause an explosion.**
- **Make sure the Earth Clip and Earth Lead are not faulty.** If you have a tester or insulation resistance meter, check for continuity between the Earth Clip and the metal part of the body. Burying an earth rod or earth plate in the ground and connecting the Earth Lead is a job for a qualified electrician so you should consult a nearby electrical contractor.
- **Before using the tool, make sure the power source to which it will be connected is fitted with an earth leakage breaker to prevent electric shock.**
- **Extension cord should be selected after ensuring the diameter is compatible with the length of the extension.** Beware of extremely long power cord (particularly wound up thin cords) as they may cause drops in voltage which weaken the magnetism, adversely affecting the performance and function of the tool. Do not share the extension cord with any other electric machine tools. (Fig. 1)

Extension Cable	
Max. Length	Nominal cross-sectional area
10 m	1.25 mm ² or more
15 m	2.00 mm ² or more
30 m	3.50 mm ² or more

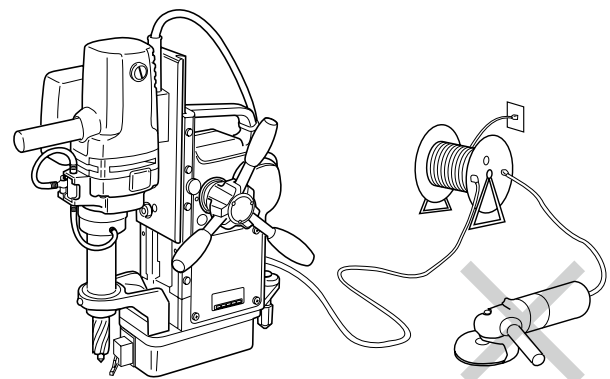

(Fig. 1)

- **When performing maintenance, inspection, replacement or adjustment of parts, make sure to disconnect the plug from the receptacle.**
- **Do not operate on the ceiling.** The tool should be operated on a horizontal place or the wall (vertically). Do not operate the tool on the ceiling (upside down). (Fig. 2) Never use this unit at the work on ceiling (upside down). Remove oil supply portion from main body and mount unit so that the cutting oil will not be spilled off when the unit is used on wall (vertically).

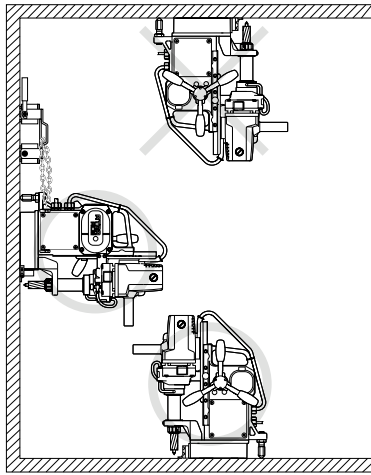

(Fig. 2)

- **Minimum workpiece thickness of 9mm.** If a workpiece is not thick enough, it will weaken the magnetism, preventing proper operation due to the slipping or lifting from the workpiece. When drilling a workpiece of insufficient thickness, it is recommended that a piece of iron, approximately 10mm thick and somewhat larger in size than that of the Magnet, be placed on the reverse side of the workpiece. (Fig. 3, Fig. 4)

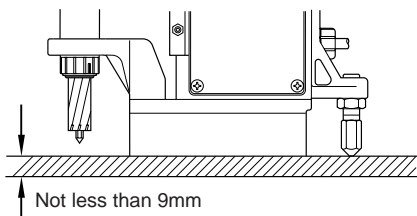

(Fig. 3)

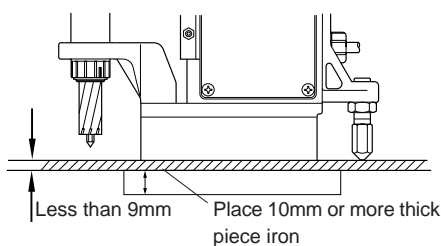

(Fig. 4)

- **Clean the adhesion surface of the Magnet and the surface of the workpiece.** Any gaps between the adhesion surface of the Magnet and the surface of the workpiece will weaken the adhesive power of the Magnet and may cause the tool to swing around. Therefore the surfaces should always be kept clean and free from metal chips, bumps and depressions or rust. Also, do not place the Magnet over holes as this will also weaken the adhesion.
- **Use the Chain to prevent the tool from falling.** Use the attached Chain to attach the tool to the workpiece where there is a risk that it might fall from a high place or tip over if the Magnet lifts off during a power stoppage or for some other reason. Use Supporting Magnet Assy (option) to prevent main body of unit from falling when the chain can not be wound around work because its size is too large to wind. (Fig. 5)

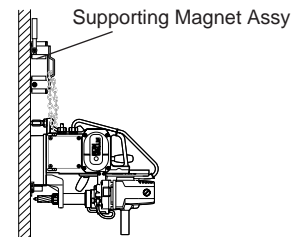
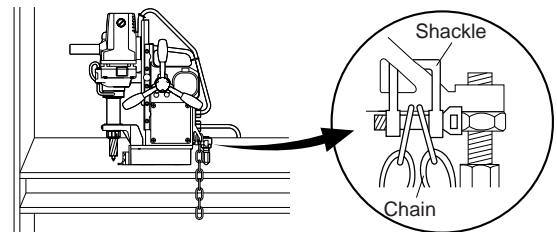

(Fig. 5)

- **Align the Magnet parallel to the length of the workpiece.** Since the surface of an H-section is normally curved as shown in Figure 6, the Magnet should be placed parallel to the length of the workpiece to ensure good adhesion and safe working. Insecure magnetic adhesion is the cause of cutter damage and unexpected accidents. (Fig. 6, Fig. 7)

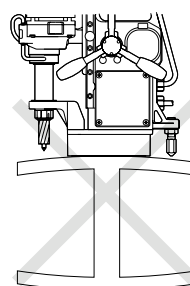

(Fig. 6)

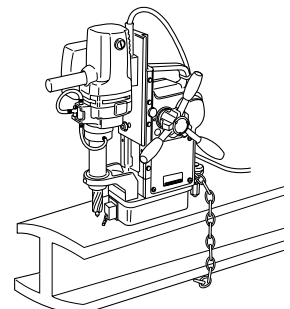

(Fig. 7)

- **Stabilizer adjustment.** The Stabilizer makes the Magnet more efficient. With the Magnet On, adjust the Stabilizer so that it comes into solid contact with the workpiece, taking care to ensure that the Stabilizer does not stick out so far that it will lift the Magnet. (Fig .8, Fig .9, Fig .10)

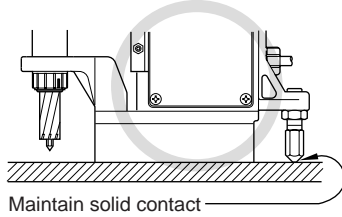

(Fig .8)

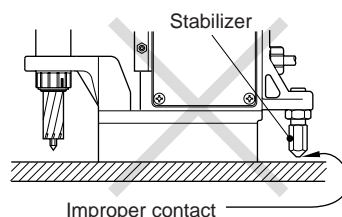

(Fig .9)

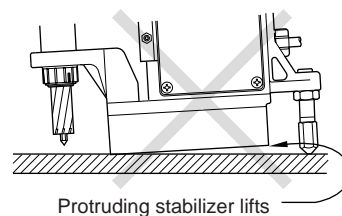

(Fig .10)

- **Beware of slag being ejected when a hole is finished. (Atra Ace Series)** Wear protective gear since slag (metal chips) is ejected with great force when a hole is finished. Do not allow unprotected people to approach the work site. When working in high places, make sure there is no one underneath and be very careful of falling slag. The slag is hot, do not touch it with bare hands.
- **When clearing away metal chips, set the Switch Knob (operating switch) to Off.** Do not touch the chips with your hands, use a rod such as a screwdriver to remove them.
- **When replacing cutters, do not touch the cutting blades with bare hands.**
- **You must use a Pilot Pin which matches the cutter.** Pilot Pins differ according to cutter type, diameter and length (depth). An accident may be caused if the cutter and Pilot Pin combination is wrong. Refer to item 5-4 cutter and Pilot Pin Combinations.
- **Do not use Cutting Oil for other purposes.** Refer to item 5-8 Preparing the Cutting Oil.

- **Do not remove labels or name plates from the tool.**

Contact the sales agent from whom you purchased the tool or an authorized dealer if a label or name plate is damaged or missing.

⚠ CAUTION

- **Set the Switch Knob to Off position before connecting the Power Plug to a power source.**
 - **Non-magnetic (aluminum, stainless steel, copper alloy, etc.) workpiece can not be used since the Magnet will have no adhesion to it.**
 - **Do not use this tool on steel which is being electric welded.** If the earthing in electric welding is inadequate, electricity will flow through the Magnet causing irreparable damage to the electric parts and may cause an accident due to faulty operation.
 - **Do not use force feed the cutter during drilling .** Hibroaches and Jetbroaches have thin cutter blades with a lower cutting resistance than twist drills. Therefore they should not be fed forcibly during manual hole making. Be careful because if more than necessary force is used the cutters will be damaged and their useful life will be shortened.
 - **Do not switch from manual to automatic operation while drilling holes.** If you wish to drill a hole using automatic feed, start with automatic feed. If you are drilling a hole with manual feed and switch to automatic feed in the middle, the Drill Motor may return.
 - **When the automatic feed is On, do not feed manually.** With automatic feed on (with the Rod Handles pushed towards the body), do not put additional feed pressure on the Rod Handles.
 - **If the unit is left in the temperature below the freezing point for long, the electric drill may not move up after the drilling operation is over or move up during the drilling poeration in the beginning, but it is not the trouble. If this erroneous motion occurs, run the drill for a few minutes under no load with the automatic feed function turned OFF (by turning the handle bar down in the outward direction.) before the normal operation.**
- Start cutting about 2 seconds after the electric drill operation has been started.**
- If cutting has been started within 2 seconds, the electric drill may be potentially stopped without ascending even if drilling has been completed.

1 USAGE

This is a machine tool which attaches magnetically to mild steel and uses the power of Drill Motor to drill holes with a Jetbroach One-touch type or Hibroach One-touch Type.(Mild steel SS400)

2 CHECK THE CONTENTS OF THE PACKAGE

Check the contents and make sure that the tool is not damaged due to an accident during the transportation, if any. The contents should correspond to the list as follows. Just in case there are some damaged or missing parts, contact the sales agent from whom you purchased the tool or an authorized dealer.

THE CONTENTS OF THE PACKAGE AND ACCESSORIES

QA-4000

Package Contents	Q'ty	check
ATRA ACE	1set	
Oil Tank Ass'y	1set	
Tool Box	1	
Pilot Pin 08035	1	
Hex. Socket Screw Key 3	1	
Hex. Socket Screw Key 4	1	
Spanner 8 × 10	1	
Cutting Oil 0.5 l Can	1	
Side Handle	1	
Chain	1	
Instruction Manual	1	

QA-6500

Package Contents	Q'ty	check
ATRA ACE	1set	
Oil Tank Ass'y	1set	
Tool Box	1	
Pilot Pin 08050	1	
Pilot Pin 08035	1	
Hex. Socket Screw Key 3	1	
Hex. Socket Screw Key 4	1	
Spanner 8 × 10	1	
Cutting Oil 0.5 l Can	1	
Side Handle	1	
Chain	1	
Instruction Manual	1	
Chip Stopper	1	

3 NAME OF PARTS

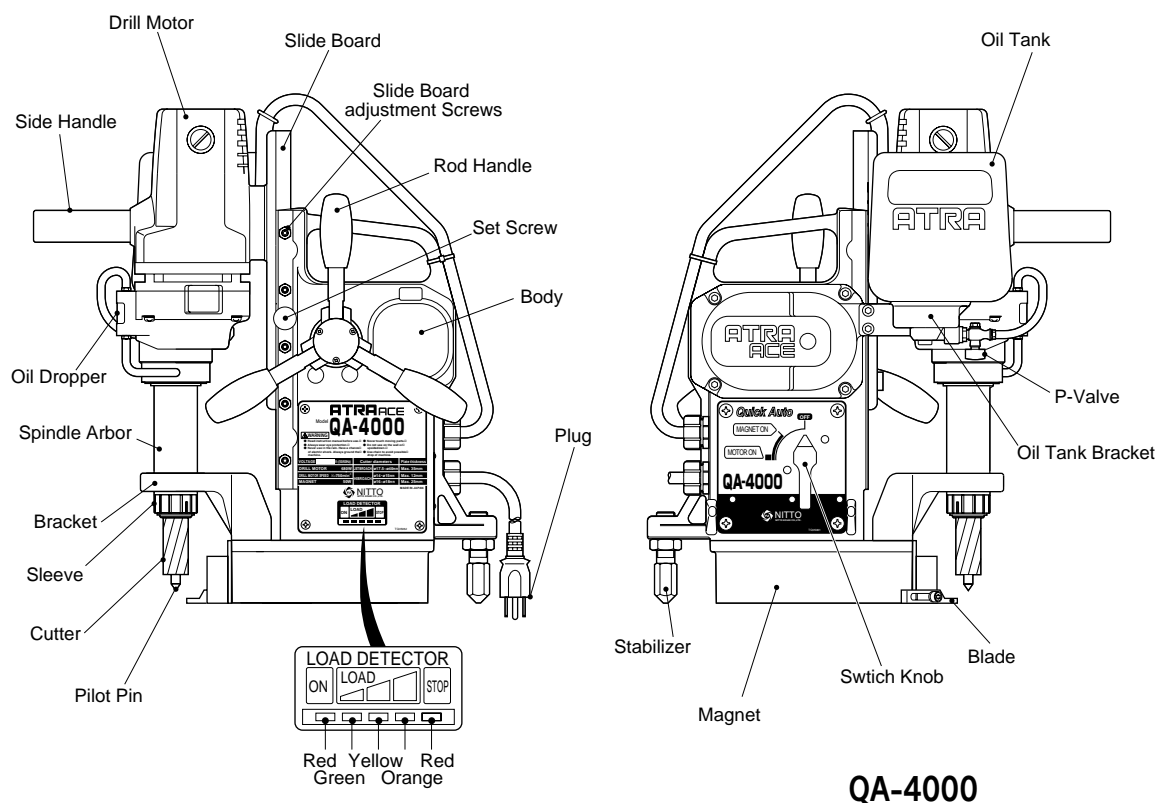

(Fig. 11)

4 ELECTRONIC CONTROL FUNCTIONS

4-1 Load Detector

If there is an overload during drilling, the following functions are automatically activated. The load detector may not function properly if the power supply is an engine generator or the power voltage is too high or too low.

(1) Load Indication Function

The lamps indicate the load on the Drill Motor. As the load increases, the indicator lamps flash on in a color sequence of green, yellow and orange starting from the left (green). (Fig. 12)

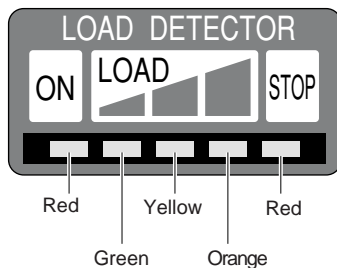

(Fig. 12)

(2) Automatic Feed Control Function

This system automatically controls the feed rate where several seconds after start-up of the drilling it automatically slowly starts to feed and then the rate varies depending on the load condition of the Drill Motor. The feed rate is also automatically regulated according to the cutter diameter.

(3) Automatic Stop Function

Both the drilling and feeding operations stop automatically and the red stop lamp comes on whenever there is an excessive load on the Drill Motor, preventing the Drill Motor and cutter from breaking. If the cutter is dull, however, breakage may be inevitable.

4-2 Automatic Return Function

When the drilling is completed and there is no longer a load placed on the Drill Motor, the feed motor automatically reverses and retracts the Drill Motor upward.

4-3 Limit Switch Function

When the stroke reaches its upper limit, the Limit Switch stops both the Drill Motor and feed. Even in case the automatic return function fails at the end of the drilling allowing the Drill Motor to continue downward, the Limit Switch stops both the Drill Motor and feed when the stroke reaches its lower limit. The green and yellow indicator lamps are lighted when the electric drill and its feed stop.

4-4 Side Slip Detection Function

If the Magnet sideways while drilling holes, the Drill Motor moves will stop turning and the feed will stop. The green and yellow indicator lamps are lighted when the electric drill and its feed stop.

4-5 Automatic Step Feed

- The switch to step feed occurs automatically when the cutter has lost its sharpness.
- When working on deep holes or large diameter holes, chips are produced intermittently and ejected smoothly.

4-6 Restart Prevention Function (For QA-6500)

- When a power failure has occurred while the tool was being used, the restart prevention function operates when the power is restored.
- If the drill stops during operation because of the interruption of the power supply or accidental unplugging of the power supply, the green and yellow indicator lamps are lighted and the magnet regains its attracting power, but the electric drill does not rotate when the power supply resumes, or is plugged.
- To resume work, turn the Switch Knob back to the Magnet On position then forward to the Motor On position and the Drill Motor will start turning.

5 PREPARATIONS

⚠ WARNING

When making preparations, set the Switch Knob (operating switch) to Off and remove the Power Plug from the power supply.

5-1 Accessory Installation

The Side Handle, an accessory, should be mounted on the Drill Motor.

5-2 Concerning Cutter Usage

⚠ CAUTION

- Cutters other than one-touch type can not be used.
- For better working and greater safety, do not use worn or broken cutters.

5-3 Cutter Precautions







When you need cutters other than the one-ouch type supplied as accessories, refer to Optional Extras, items 10-2, 10-3 and 10-4, before you buy.

5-4 Cutter and Pilot Pin Combinations

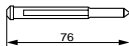





⚠ WARNING

Do not use combinations other than those in the Conformity Tables. Match the appropriate Pilot Pin to the cutter which is to be used.

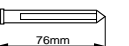
- Match the appropriate Pilot Pin to the cutter which is to be used. (Fig. 13), (Fig. 14)

CUTTER AND SUITABLE PILOT PIN QA-4000			
PILOT PIN		CUTTER	
TJ12694	PILOT PIN 07025 	Cutter Dia 14 mm, 15 mm Depth 12 mm	HIBROACH ONE-TOUCH TYPE 
TJ12696	PILOT PIN 08025 	Cutter Dia 16 mm, 17 mm Depth 25 mm	HIBROACH ONE-TOUCH TYPE 
TJ15859	PILOT PIN 08035 	Cutter Dia 17.5 to 40 mm Depth 35 mm	JETBROACH ONE-TOUCH TYPE 

(Fig. 13)

CUTTER AND SUITABLE PILOT PIN QA-6500			
PILOT PIN		CUTTER	
TJ12696	PILOT PIN 08025 	Cutter Dia 18 to 35 mm Depth 25 mm	HIBROACH ONE-TOUCH TYPE 
TJ15859	PILOT PIN 08035 	Cutter Dia 17.5 to 40 mm Depth 35 mm	JETBROACH ONE-TOUCH TYPE 
TJ16019	PILOT PIN 08050 	Cutter Dia 17.5 to 65 mm Depth 50 mm	JETBROACH ONE-TOUCH TYPE 

(Fig. 14)

- Pilot Pins differ according to the type, diameter and length (depth) of the cutter. If the cutter and Pilot Pin combination is wrong, the cutter will be damaged due to failure to eject the slag (metal chips) formed after cutting and poor Cutting Oil supply.
- Unspecified usage not only significantly reduces the life of the cutter but also damage the cutter and lead to unexpected accidents.

5-5 Mounting and Dismounting the Cutter

⚠ WARNING

- You must use a Pilot Pin which matches the cutter.
An accident may be caused if the cutter and Pilot Pin combination is wrong.
- Do not touch cutting blades with bare hands.

(1) Raise the Drill Motor by turning the Rod Handles in the clockwise direction. (Fig. 15)

(2) Take the Pilot Pin which suits the size of cutter to be used and insert the Pilot Pin in the cutter. (Fig. 16)

(3) Align the depression in the cutter with the white line on the Sleeve and insert the cutter. (Fig. 17) When the cutter is pushed right in, the Sleeve can be turned to the right and will lock into place with a click.

※ If the cutter will not go in, turn the Sleeve to the left and try again.

(4) To remove the cutter, turn the Sleeve to the left and pull out the cutter. (Fig. 18)

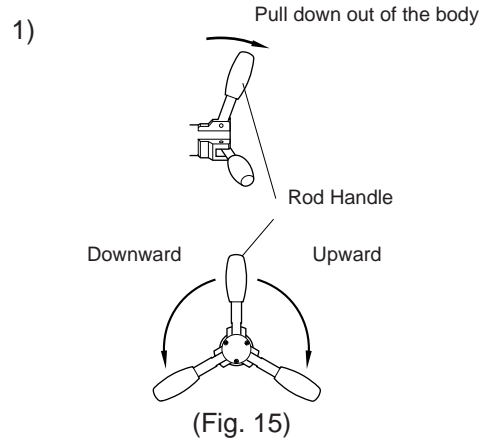

(Fig. 15)

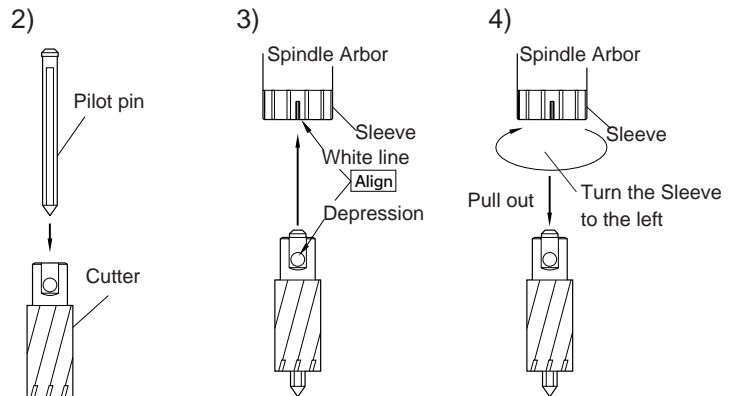



(Fig. 16), (Fig. 17), (Fig.18)

5-6 Setting the Change Lever (For QA-6500)

Change the drill speed to suit the type and size of the cutter. (Fig. 19)

Note: Set the Switch Knob (operation switch) to the Off position and wait until the drill has stopped turning before operating the change lever.

Position of drill speed		
Rotation	1 400 min ⁻¹	2 750 min ⁻¹
Applicable cutter size	Hibroach One-touch Type 19.5 to 35 mm dia.	Hibroach One-touch Type 18 to 19 mm dia.
	Jetbroach One-touch Type 36 to 65 mm dia.	Jetbroach One-touch Type 17.5 to 35 mm dia.

(Fig. 19)

5-7 Preparation of chip breakers

WARNING

- Set the chip breaker so that the tips of the blade and chip stopper may not interfere with the cutting tool both at the top and bottom in setting up the chip breaker.

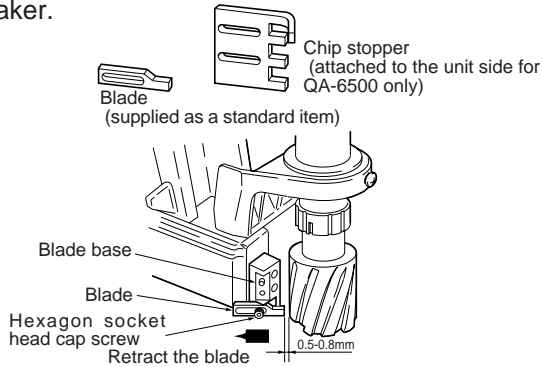

(Fig.20)

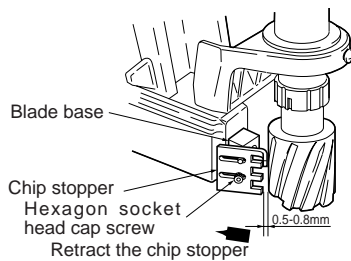

(Fig. 21)

The chip breaker is to cut cutting chips in randomly short length produced during the drilling operation for easy discharge of the cutting chips.

- The blade is mounted on the magnet as the standard item.
- QA-6500 model only is supplied with the chip stopper. It can cut produced cutting chips in more proper length during the cutting operation with the cutter diameter of 40mm to 65mm diameter. (Cutters other than 40mm to 65mm diameter can not be used.)

(1) Setting the blade (See the fig. 20)

(1-1) Mounting the cutter

Loosen the hex. socket head cap screw and retract the blade in the arrow direction until it can not retract any further, and then mount the cutter.

(1-2) Setting the blade

Set the blade with the gap between the cutter and tip of the blade being 0.5mm to 0.8mm, securely mount it on the blade base with the hex. socket head cap screw.

(2) Setting the chip stopper (See the fig. 21) (It is supplied with QA-6500 model only.)

(2-1) Mounting the chip stopper

Loosen the hex. socket head cap screw fastening the blade, and remove the blade and hex, socket head cap screw.

Mount on the blade base with the removed hex. socket head cap screw the chip stopper attached to the unit side with the accessory band. (Attach the removed blade to the unit side with the accessory band to avoid losing it.)

(2-2) Mounting the cutter

Loosen the hex. socket head cap screw, retract the chip stopper in the arrow direction until it can not retract further, and mount the cutter.

(2-3) Setting the chip stopper

Set the chip stopper with the gap between the cutter and tip of the chip stopper being 0.5mm to 0.8mm, and securely fix the stopper to the blade base with the hex. socket head cap screw.

5-8 Preparing the Cutting Oil

Safety Notes on Cutting Oil

WARNING

(1) Application and Usage Limitations

- Use only as a cutting fluid. Not for use in ordinary households.

(2) Precautions on Handling Cutting Oil

- This liquid contains amines. It should not be mixed with rust preventives containing nitrite.
- May cause inflammation if it enters the eyes. Protective eye-wear should be used when handling to prevent entry into the eyes.
- Skin contact may cause inflammation. Protective gloves should be worn when handling to prevent contact with the skin.
- May cause discomfort if mist or vapor is inhaled. Breathing apparatus should be used when handling and mist or vapor should not be inhaled.
- Dilution should be carried out in accordance with the Instruction Manuals.
- Keep it out of reach of children.
- Do not drink it.

(3) Emergency Treatment

- If it has entered eyes, immediately open the eyelids as wide as possible and wash thoroughly with water for at least 15 minutes. If there is inflammation, consult a physician and follow the instructions.
- If it has contacted the skin, wash immediately with soap and water. Soiled clothing should be removed and laundered thoroughly before re-use. If there is inflammation, consult a physician and follow the instructions.

- If mist or vapor has been inhaled, immediately transfer the patient to fresh air, cover his/her body with a blanket and keep warm and quiet. Consult a physician and follow the instructions.
- If it has been ingested, immediately give copious water and induce vomiting. Consult a physician and follow the instructions. If the patient is unconscious, do not administer water or induce vomiting.

(4) In Case of Fire

- For a fire in the vicinity, wear protective equipment and extinguish the fire from upwind with foam, powder or CO₂ fire extinguishers.

(5) Method of Storage

- Seal after use to prevent admixture with dirt and/or water.
- Store in a cool dark place away from direct sunlight and rain.

(6) Method of Disposal

- Disposal of undiluted and diluted fluid should be handled as waste fluid in accordance with the law by a waste disposal specialist.
- Wash water should be treated by pH adjustment, flocculation and settling, activated sludge treatment, activated carbon adsorption, etc., and discharged in accordance with municipal standards.
- Since empty containers contain dregs, they should be handled with care.

(7) Other

- If transferred to other containers for use, the names of chemicals used in the workplace and the labeled contents should be displayed and kept together with the Instruction Manuals ready for immediate perusal.
- Anyone wishing to have further details may request product safety data sheets from manufacturer.
- The inscribed details are based on currently available information and data and updated by new knowledge.
- Items to be noted are aimed at normal handling. Where special handling is involved, safety measures appropriate to the application and method of handling should be implemented.
- The inscribed details are submitted for your information and do not imply assurances or acceptance of responsibility.

5-8-1 Preparing the Cutting Oil

(1) Use our authentic Cutting Oil (light blue). Cutting performance and cutter life may be reduced if other Cutting Oils are used.

(2) Dilute the Cutting Oil eight to ten times with tap water.

(3) The Oil Tank is a cartridge type tank. Remove it from the Oil Tank Bracket and fill it with Cutting Oil away from the tool so that oil will not be spilled on the tool. The Oil Tank should be installed so that its cap fits in the Oil Tank Bracket. (Fig. 22) When drilling is being conducted on a continuous basis, it is recommended that another tank be prepared so that operations can be continued easily by just changing the Oil Tank, even when the oil in the former tank runs out during the operation.

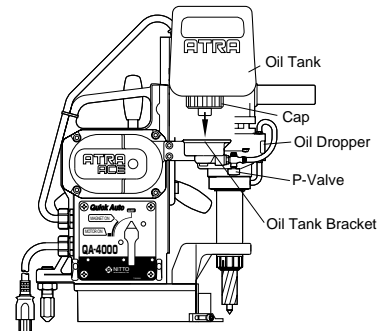

(Fig. 22)

Part No.	Part Name
TB03700	Oil Tank Ass'y

5-8-2 Flow Rate Control

The Cutting Oil flow is controlled by adjusting the P-Valve on the Oil Tank Bracket and observing the Oil Dropper on the front of the Drill Motor. As a guide for the oil feed rate it is generally recommended that the slags (chips) be kept constantly wet during the drilling and free from discoloration due to burning etc. The flow rate adjustment should be performed during drilling or when the Pilot Pin is depressed after lowering the Drill Motor. The P-Valve should be closed when operations are interrupted for a long period of time. (Fig. 23)

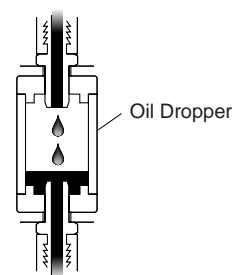

(Fig. 23)

5-9 Inserting the Power Plug into the Power Source

⚠ CAUTION

Set the switch to Off before inserting the Power Plug.
The power supply voltage used must be correct.

6 HOW TO OPERATE THE TOOL

⚠ WARNING

Wear the safety goggle while working. If much dust is produced, wear a dust mask.

6-1 Start and Stop

⚠ CAUTION

- Switch On and Off in stages.
- Unless the switch is set to On in stages, the Drill Motor may not start.

(1) Magnet On

Turn the Switch Knob to the Magnet On position. The power lamp will come on and the Magnet will activate. (Fig. 24)

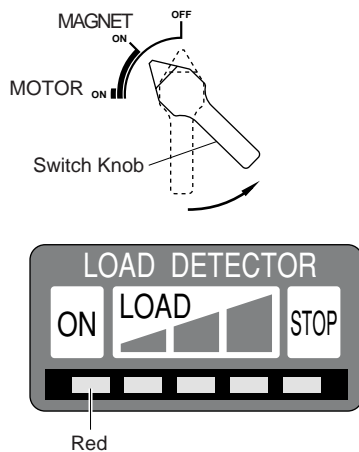

(Fig. 24)

(2) Drill Motor On

Set the Switch Knob to the Motor On position. The Drill Motor will run. (Fig. 25)

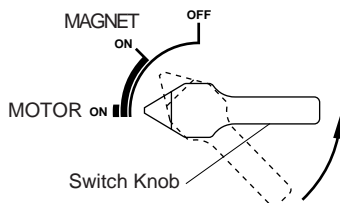

(Fig. 25)

(3) All Stop

When the Switch Knob is set back from the Motor On position to the Magnet On position, the Motor will stop. When the Switch Knob is set further back from Magnet On position to the Off position, the Magnet will be deactivated and all functions will stop.

6-2 Use Manual Feed for Elongated Holes

⚠ WARNING

Always use manual feed for making elongated holes and work slowly.

- Elongated holes should be drilled in sequence of ①→②→③. Holes ② and ③ should be drilled manually without excessive pressure on the cutter. Avoid drilling elongated holes with automatic feed since it may cause the cutter to break or cause unexpected accidents. File away any excesses. (Fig. 26)

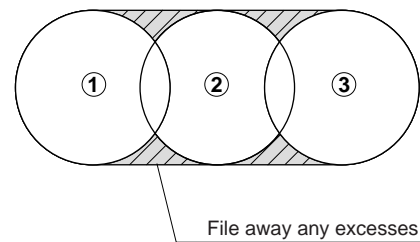

(Fig. 26)

- When making elongated holes, be sure to move far enough sideways for the Pilot Pin to be engaged before making the next hole.

6-3 Use Manual Feed for Drilling Laminated Plates

⚠ CAUTION

- Always use manual feed for drilling laminated plates and work slowly.
- Laminations must be clamped together securely.
- When drilling laminated plates, raise the cutter when the top plate has been drilled and remove the slag (metal chips) from the hole. Then drill the lower plate.
- Not removing the slag (metal chips) will cause the cutter to bind and lift the Magnet.

6-4 Drilling Procedure

(1) Punching

The punch hole should be vertical with respect to the workpiece and rather large in size. Precisely place the punch hole since it serves as a drilling guide. (Fig. 27)

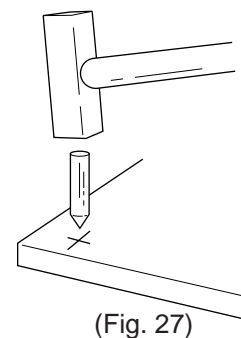

(Fig. 27)

(2) Make sure that both the Magnet adhesion surface and the workpiece surface are clean.

⚠ CAUTION

If foreign matter is caught between the surfaces, there is a danger that the tool may be spun around.

Gaps between the Magnet adhesion surface and the workpiece weaken the magnetic holding power. Always keep the Magnet adhesion surface free from foreign matter (such as metal chips), unevenness, and rust.

(3) Align with punch hole

Turn the Rod Handles in the counterclockwise direction to lower the cutter gently and align the tip of the Pilot Pin with the punch. (Fig. 28)

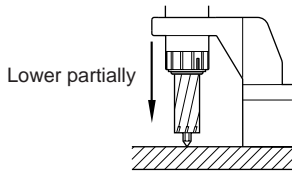

(Fig. 28)

(4) Magnet on

⚠ CAUTION

Make sure the Magnet is clinging to the workpiece.

Turning the switch to the Magnet On position causes the Magnet lamp to come on and activates the Magnet. (Fig. 29)

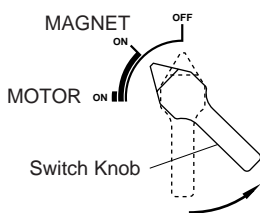

(Fig. 29)

(5) Stabilizer adjustment

⚠ CAUTION

The Stabilizer serves to use the adhesive force of the Magnet effectively. After switching on the Magnet, adjust it so that the Magnet clings to the workpiece. Make sure the Stabilizer is not protruding too far and lifting the Magnet. (Fig. 30)

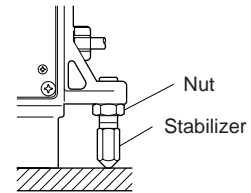

(Fig. 30)

(6) Cutting Oil control.

When the P-Valve on the Oil Tank Bracket is open and the Drill Motor is lowered by turning the Rod Handles in the counterclockwise direction, the Pilot Pin will be pushed up allowing the Cutting Oil to begin to flow. Adjust the oil flow rate by observing the Oil Dropper on the front of the Drill Motor. (Fig. 31)

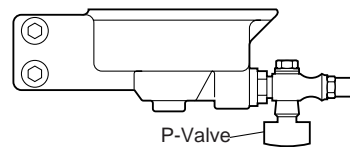

(Fig. 31)

(7) Drill Motor on

⚠ CAUTION

Do not touch the rotating parts.

Turning the Switch Knob to Motor On position starts the Drill Motor running. (Fig. 32)

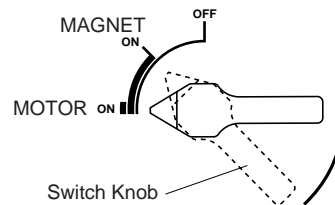

(Fig. 32)

(8) Automatic feeding

⚠ CAUTION

- Once it has started to feed, do not touch the Rod Handles until the drilling is finished.
- Do not use automatic feed if the finish side is slanted.

Pushing the Rod Handles towards the body activates the automatic feeding. The feed in the first stage of the cutting operation is automatically slow and manual feed is not required. (Fig. 33)

Start cutting about 2 seconds after the electric drill operation has been started.

If cutting has been started within 2 seconds, the electric drill may be potentially stopped without ascending even if drilling has been completed.

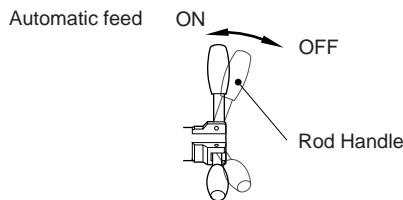

(Fig. 33)

When drilling a hole in an angle, channel or H-section, etc., the cutter may be damaged when it comes to a slanted or radiused surface on the finish side. Feed slowly when starting and finishing. (Fig. 34)

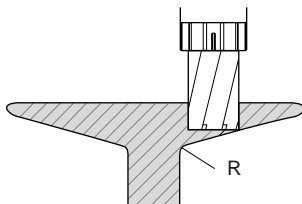

(Fig. 34)

(9) Finishing the holes

⚠ CAUTION

Beware of ejected slags when finishing the holes. Never touch the slags with bare hands since they are hot and sharp.

When the drilling is finished, the Drill Motor will rise automatically and stop. When it has stopped, pull the Rod Handles to the outside to switch off automatic feed. Then quickly set the Switch Knob to the Off position. If you fail to do this, current will continue to flow in the Magnet and shorten its life. (Fig. 35)

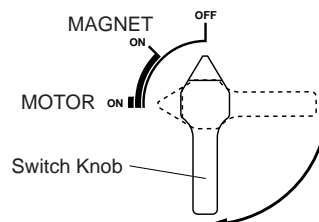

(Fig. 35)

(10) Slag removal

Do not start the next drilling with slag remaining on the cutter.

When the drilling is completed, the spring loaded Pilot Pin automatically ejects the slags. If, however, slags do not eject and the inside of the cutter unit is clogged with slags, the subsequent drilling will fail. In this case, remove slags by hitting its flange part with a thin punch.

(Fig. 36)

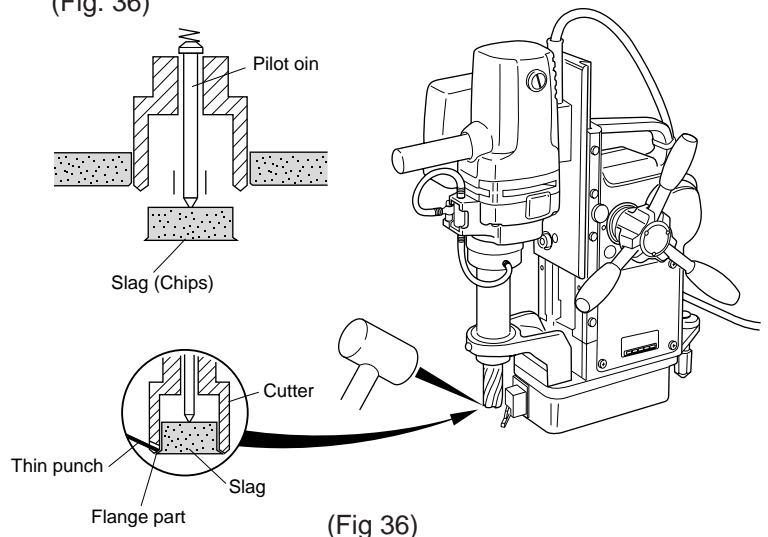

(Fig. 36)

7 TROUBLESHOOTING

WARNING

- Do not attempt to repair the tool yourself. This will cause damage to the tool and danger to yourself when you use it again.
- If any of the following, or other symptoms occur, or if there are other matters concerning usage that you do not understand, please consult the sales agent from whom you purchased the tool or an authorized dealer.

This tool is controlled by electronic functions and will stop automatically if the electronic control system malfunctions due to power supply noise. During drilling, the following symptoms are not considered to be problematic. For safety reasons, check the tool only after ensuring the Switch Knob is set to Magnet On, the Rod Handles are pushed outside, and the automatic feeding is Off and the Drill Motor retracted:

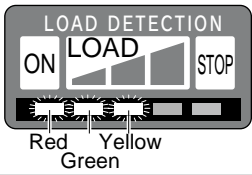
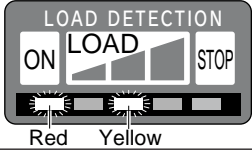
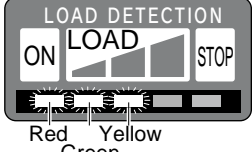
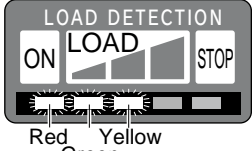
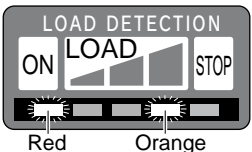
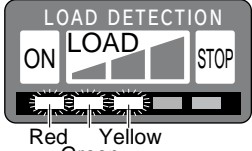
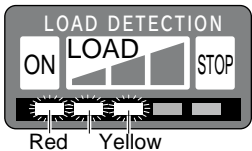
Problems	Causes	Solutions	Lamp indications
Electric drill does not start rotation when the switch knob is turned ON.	The limit switch is tripped adjacent to the upper or lower stroke limit.	Reset the limit switch by moving the electric drill a little upward or downward.	 Red Yellow Green
	Electro-Magnet does not have the holdingpower (somehow, the coil is cut off)	Replace the faulty Magnet Part.	 Red Yellow
Electric drill moves up and stops when the automatic feed is turned ON.	The drill is operated in the manual feed mode.	Turn the automatic feed ON in the beginning of a drilling operation.	 Red Yellow Green
Electric drill stops and moves up in the middle of drilling a hole.	Sudden drop in voltage	Avoid wiring which may cause voltage variation (Putting many loads on one outlet prohibited)	 Red Yellow Green
The entire unit stops its operation during drilling a hole and the orange indicator lamp is lighted.	Sufficient cutting fluid is not supplied.	Increase the supply of the cutting fluid in volume.	 Red Orange
	Cutting dusts or chips stuff the cutter tip.	Remove them.	
	Cutter tip is worn out.	Sharpen the cutter or replace it with new one.	
The Side slip detection function is actuated as the magnet slips sideways to stop the unit entire operation and to light the green and yellow indicator lamps.	The work is too thin.	Fit a 10mm or thicker iron plate in the back of the work.	 Red Yellow Green
	Cutting chips or the like are stuck in the bottom of the magnet.	Clean the bottom free of foreign matters.	
	The cutter tip is worn out.	Sharpen it or replace it with new one.	
	The magnet is defective.	Replace it.	
Electric drill does not move up but stops at the bottom stroke end after a hole drilling process is completed.	The hole is drilled with the drilling load scarcely needed. (The work is too thin.)	Operate the process all over again from the beginning.	 Red Yellow Green
	Cutting started immediately after electrical drill started		
	Lubrication oil runs out in the spindle arbor and needle bearings.	Refill lubrication oil.	

Inquire the sales agent from you purchased or an authorized dealer if you have above or other troubles, or any questions concerning the operation of the unit.

8 MAINTENANCE AND INSPECTION

⚠ WARNING

Switch off and remove the power plug from the power supply during maintenance and inspection.

⚠ CAUTION

Check all attached parts periodically for loose screws. Securely tighten any loose screw.

8-1 Tighten the Set Screw when the tool is not in use

For safety reasons, when the tool is not in use or when the drilling operation is suspended, keep the Drill Motor from moving downward due to its dead weight by tightening the stopper set screw with the Drill Motor in an elevated position. If the Drill Motor is left down, the Pilot Pin or cutter may be damaged during transit.

(Fig. 37)

8-2 Greasing of sliding surfaces

From time to time, the sliding surfaces between the body and the Slide Board should be greased. (Fig. 37)

8-3 Loose Slide Board adjustment

Any looseness between the body and the Slide Board will adversely affect drilling precision, leading to premature wear on the cutter. When looseness is encountered, eliminate it by uniformly re-tightening the four Slide Board adjustment screws on the lateral side of the body to the extent that the Drill Motor will not fall under its dead weight. The screws are designed to work as a double-lock, so they should be securely tightened by turning the nuts. Do not adjust using the Set Screws. (Fig. 37)

8-4 Inspection of the Bracket

The Bracket which supports the Spindle Arbor is of key importance in maintaining drill precision. The Bracket is tightened by three screws, which should be inspected from time to time to ensure they are tight.

(Fig. 37)

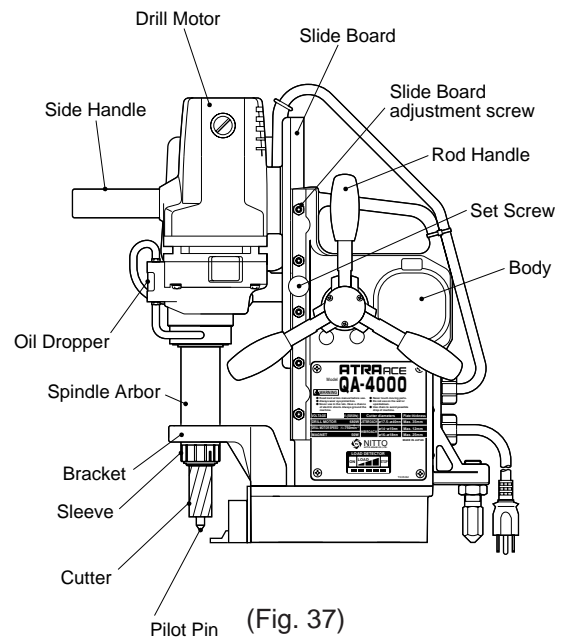

8-5 Sharpening of Pilot Pin tip

If the Pilot Pin tip is dull, the pin will not be able to fit itself into the punching hole, causing poor drilling precision. It should be inspected from time to time, and, if the Pilot Pin tip is found to be dull, sharpen the tip or replace with a new one. Exercise caution during the sharpening operation as any rough grinding softens the tip due to annealing, even to the point of disabling it in some cases. (Fig. 38)

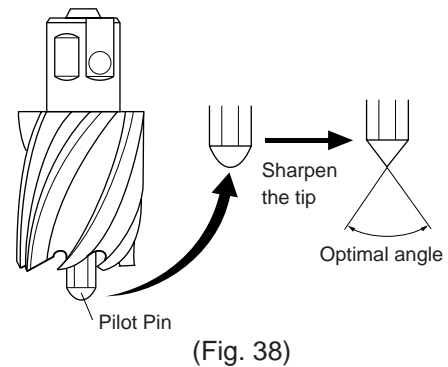

8-6 Loosening a tight Pilot Pin

When the cutter needs to be replaced, pull out and change the Pilot Pin which acts as a guide. However, if metal chips are caught between the cutter and the pin, the pin may be difficult to be pulled out. Tap the end of the pin gently with a wooden mallet as you pull it out.

(Fig. 39)

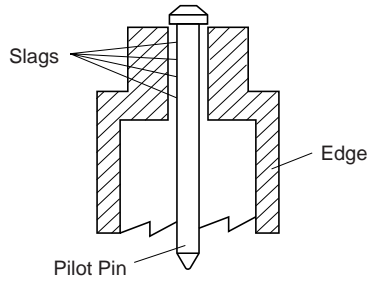

(Fig. 39)

8-7 Cutter grinding

When the cutter needs re-grinding, consult the sales agent from whom you purchased the tool or an authorized dealer.

8-8 Inspecting and replacing Carbon Brushes

The worn condition of the Carbon Brushes should be inspected periodically.

Commutation will deteriorate when the remaining length is about 5mm and may cause a breakdown so the brushes should be replaced in accordance with the following procedure. (Fig. 43)

- (1) Remove the Brush Cap with a screwdriver. (Fig. 44)
- (2) Remove the worn brush, replace it with a new one and refit the Brush Cap. (Fig. 44)
- (3) After replacement, run the tool under no load for about ten minutes.

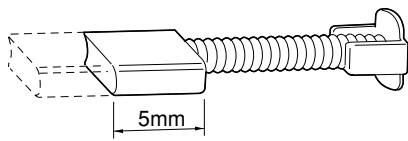

(Fig. 43)

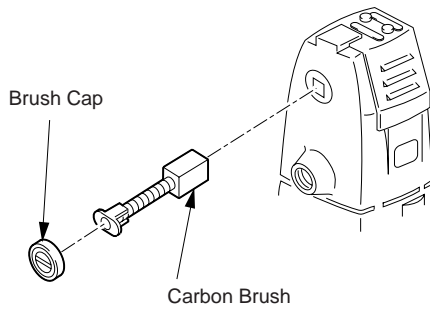

(Fig. 44)

9 ORDERING SERVICE PARTS

In ordering parts and components from the sales agent from whom you purchased the tool or an authorized dealer, give each part number, parts name and quantity required.

9-1 Genuine Cutting Oil

⚠ CAUTION

Use our Genuine Cutting Oil.

Part No.	Part Name
TB01507	Water-soluble Cutting Oil 2 ℓ (Light Blue)

9-2 Pilot Pin

⚠ CAUTION

Whenever you buy a cutter, should also buy a Pilot Pin to suit.

(metric sizes)

Part No.	Part Name	Applicable cutter (mm)
TJ12694	Pilot Pin 07025(B1)	Hibroach 14 to 17 dia.
TJ12696	Pilot Pin 08025(A1)	Hibroach 17.5 to 35 dia.
TJ15859	Pilot Pin 08035(A2)	Jetbroach 35 depth
TJ16019	Pilot Pin 08050(A3)	Jetbroach 50 depth

9-3 Supporting Magnet Assy

Part No.	Part Name
TB04374	Supporting Magnet Assy

9-4 Ordering parts

Hibroach One-touch Type (metric sizes)

QA-4000

Part No.	Diameter × Depth	Part No.	Diameter × Depth	Part No.	Diameter × Depth
TK00331	14 × 12	TK00333	16 × 25	TK00335	17.5 × 25
TK00332	15 × 12	TK00334	17 × 25	TK00336	18 × 25

Hibroach One-touch Type (metric sizes)

QA-6500

Part No.	Diameter × Depth	Part No.	Diameter × Depth	Part No.	Diameter × Depth	Part No.	Diameter × Depth
TK00336	18 × 25	TK00343	22.5 × 25	TK00350	26.5 × 25	TK00357	33 × 25
TK00337	19 × 25	TK00344	23 × 25	TK00351	27 × 25	TK00358	33.5 × 25
TK00338	19.5 × 25	TK00345	23.5 × 25	TK00352	28 × 25	TK00359	34 × 25
TK00339	20 × 25	TK00346	24 × 25	TK00353	29 × 25	TK00360	34.5 × 25
TK00340	21 × 25	TK00347	24.5 × 25	TK00354	30 × 25	TK00361	35 × 25
TK00341	21.5 × 25	TK00348	25 × 25	TK00355	31 × 25		
TK00342	22 × 25	TK00349	26 × 25	TK00356	32 × 25		

Jetbroach One-touch Type (metric sizes)

QA-4000, QA-6500

Part No.	Diameter × Depth	Part No.	Diameter × Depth	Part No.	Diameter × Depth	Part No.	Diameter × Depth
TK00301	17.5 × 35	TK00310	22 × 35	TK00318	26.5 × 35	TK00326	34 × 35
TK00302	18 × 35	TK00311	22.5 × 35	TK00319	27 × 35	TK00328	35 × 35
TK00304	19 × 35	TK00312	23 × 35	TK00320	28 × 35	TK00602	36 × 35
TK00305	19.5 × 35	TK00313	23.5 × 35	TK00321	29 × 35	TK00603	37 × 35
TK00306	20 × 35	TK00314	24 × 35	TK00322	30 × 35	TK00604	38 × 35
TK00307	20.5 × 35	TK00315	24.5 × 35	TK00323	31 × 35	TK00605	39 × 35
TK00308	21 × 35	TK00316	25 × 35	TK00324	32 × 35	TK00606	40 × 35
TK00309	21.5 × 35	TK00317	26 × 35	TK00325	33 × 35		

Jetbroach One-touch Type (metric sizes)

QA-6500

Part No.	Diameter × Depth	Part No.	Diameter × Depth	Part No.	Diameter × Depth	Part No.	Diameter × Depth
TK00380	17.5 × 50	TK00394	25 × 50	TK00408	38 × 50	TK00443	52 × 50
TK00381	18 × 50	TK00395	26 × 50	TK00409	39 × 50	TK00444	53 × 50
TK00382	19 × 50	TK00396	26.5 × 50	TK00410	40 × 50	TK00445	54 × 50
TK00383	19.5 × 50	TK00397	27 × 50	TK00411	41 × 50	TK00446	55 × 50
TK00384	20 × 50	TK00398	28 × 50	TK00412	42 × 50	TK00447	56 × 50
TK00385	20.5 × 50	TK00399	29 × 50	TK00413	43 × 50	TK00448	57 × 50
TK00386	21 × 50	TK00400	30 × 50	TK00414	44 × 50	TK00449	58 × 50
TK00387	21.5 × 50	TK00401	31 × 50	TK00415	45 × 50	TK00450	59 × 50
TK00388	22 × 50	TK00402	32 × 50	TK00416	46 × 50	TK00451	60 × 50
TK00389	22.5 × 50	TK00403	33 × 50	TK00417	47 × 50	TK00607	61 × 50
TK00390	23 × 50	TK00404	34 × 50	TK00418	48 × 50	TK00608	62 × 50
TK00391	23.5 × 50	TK00405	35 × 50	TK00419	49 × 50	TK00609	63 × 50
TK00392	24 × 50	TK00406	36 × 50	TK00420	50 × 50	TK00610	64 × 50
TK00393	24.5 × 50	TK00407	37 × 50	TK00442	51 × 50	TK00611	65 × 50